

MSO Series 3 in 1 Analyzer (Protocol + Logic + Simple DSO) Manual



Publish: 2020/08

Table of Contents

Chapter 1	Installation and Settings	3
	Hardware Installation.....	3
	Software installation.....	3
	Specification Table	6
	Specification Table (International & Microchip).....	8
Chapter 2	Function list and operation.....	10
	Protocol Analyzer.....	10
	File.....	10
	Operating mode and memory setting.....	13
	Show Waveforms	19
	Search	19
	To the end	20
	Window	20
	Saved as text file	21
	Detail window	21
	Statistics window	22
	Hide Data window.....	23
	Stack Oscilloscope	24
	Cursor	25
	Logic Analyzer	26
	File.....	27
	Capture	32
	Advanced Capture Settings.....	49
	Cursor	53
	Waveform And Report	56
	Report Area.....	58
	Bus Decode Settings.....	60
	Customized Report Settings.....	60
Chapter 3	Technical Support	61

Chapter 1 Installation and Settings

Hardware Installation

Connect the USB 3.0 cable to the USB slot on the computer (Pic.1). After confirming that the connection is complete, you can turn on the software and connect the signal cable to the object to be tested for observation. Before the measurement, please make sure the GND has been correctly connected. If it is possible, we suggest twisted pair the Data Pin and GND to improve the signal quality (Pic.2). If the signal speed is over 150MHz, please use the short cable for measurement

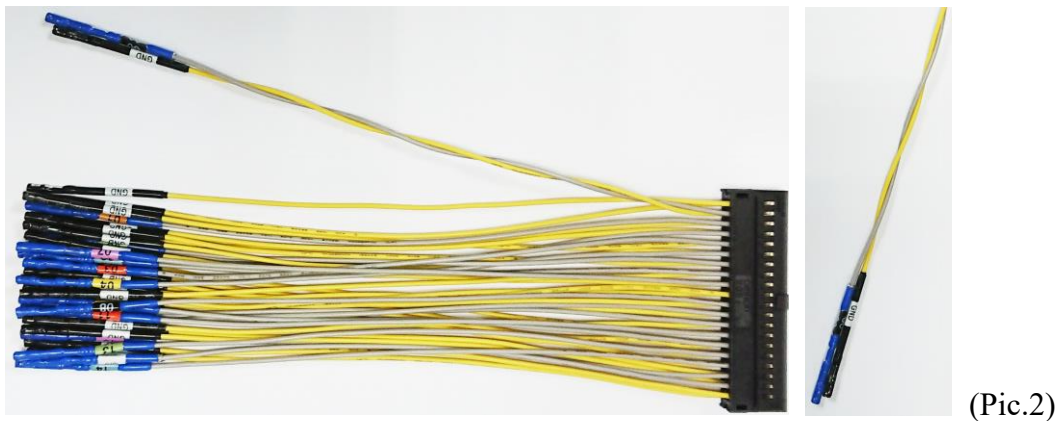

Software installation

Please visit the official website of Acute Technology Inc., go to the Download page, and then select and download the MSO series. After completion of installation, the “start icon” of MSO series will appear on the desktop and the program set. You can select either one to start MSO (). After starting the software, the main menu screen will show up. You can choose to enter logic Analyzer or protocol Analyzer.

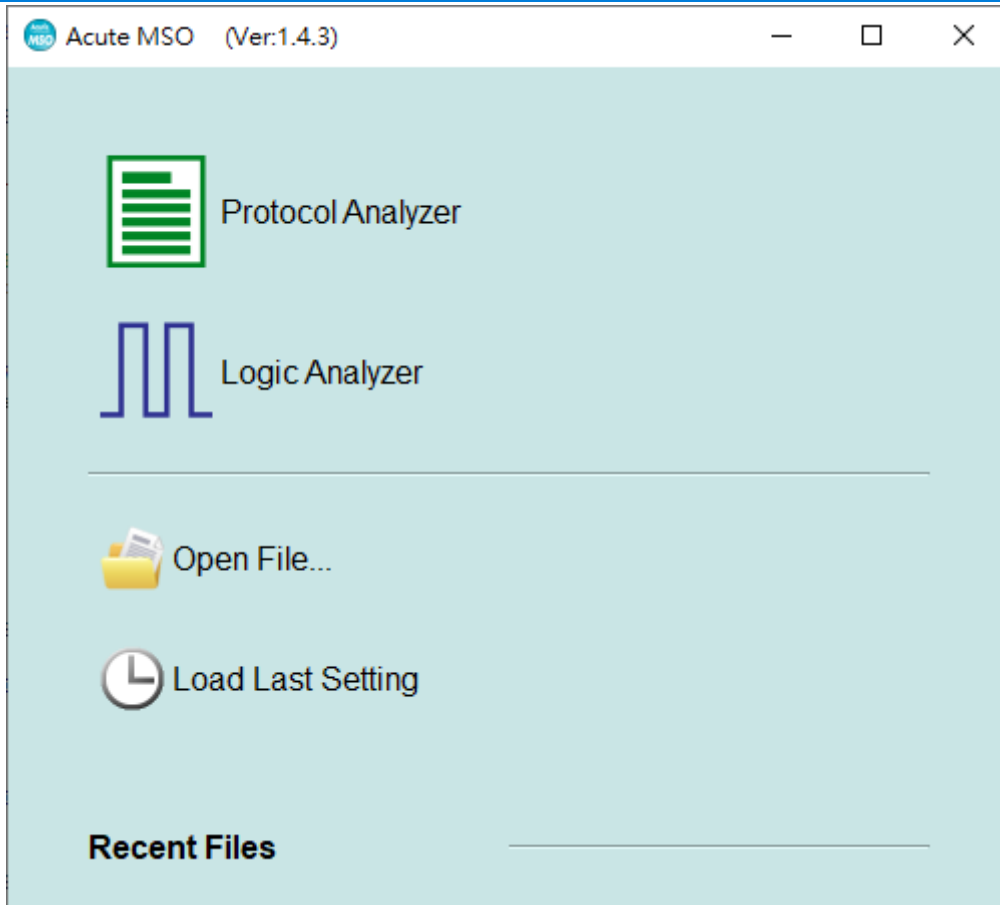

Or after entering the function window , you can select the icon below to add Logic Analyzer or Protocol Analyzer window



Or click the Add Logic Analyzer or Add Protocol Analyzer window within the file functions.



For the first-time use, the following screen will show up. Please set up the working directory that you will surely use. It is recommended that you choose the hard disk with larger remaining space for the storage of the working directory.

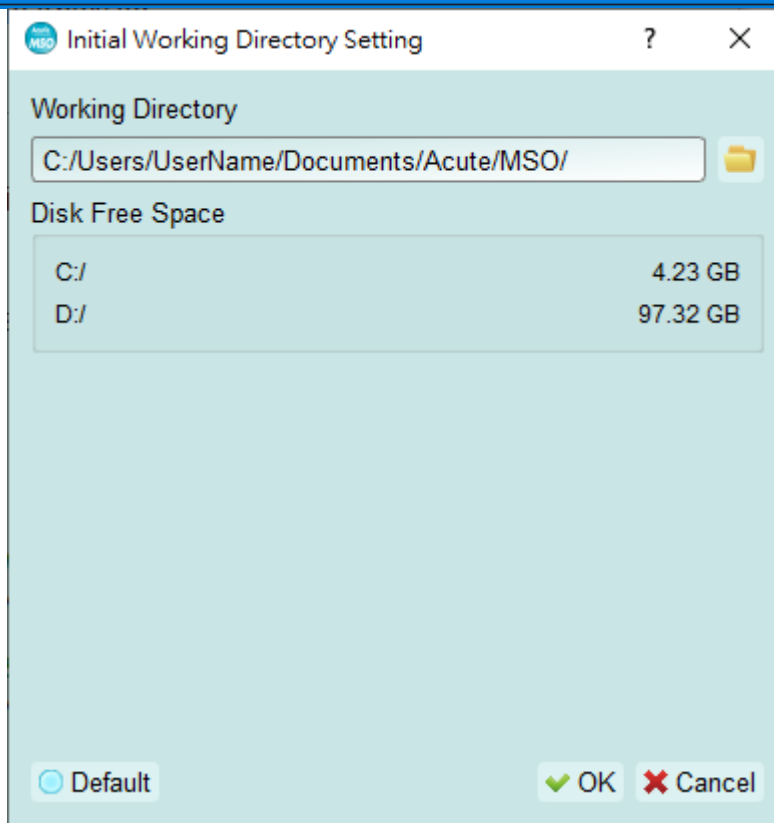

Specification Table

Model		MSO1008E	MSO1116E	MSO2116B	MSO2216B	MSO2216B+
Power	Power Source	USB bus-power (+5V)				
	Static Power Consumption	0.9W				
	Max Power Consumption	< 3.9W	< 6W			
Hardware Interface		USB3.0				
Channels (Data / Clock / Ground)		8 / 1 / 23	16 / 1 / 23			
Total Memory		2Gb	4Gb	8Gb		
Analog Input	Channels	Group I (CH0~7)	Group I, II (CH0~7, CH8~15)			
	Sample Rate(Group I 或 II)	200MHz / 1CH, 100MHz / 2CH, 25MHz / 8CH				
	Sample Rate(Group I 或 II)	The minimum value of Group I or II settings				
	Bandwidth	40MHz				
	ADC Bits	12				
Digital Input	Timing Analyzer (Asynchronous)	Available channels (Conventional / Transitional Timing) - Memory per channel				
	2 GHz	(4 / 3)– 512 Mb	(4 / 3)– 1 Gb	(8 / 7)– 512 Mb	(8 / 7)– 1 Gb	
	1 GHz	(8 / 6)– 256 Mb	(8 / 6)– 512 Mb	(16 / 14)– 256 Mb	(16 / 14)– 512 Mb	
	500 MHz	(8 / 6)– 256 Mb	(16 / 12)– 256 Mb	(16 / 16)– 256 Mb	(16 / 16)– 512 Mb	
	250 MHz and lower	(8 / 6)– 256 Mb	(16 / 16)– 256 Mb	(16 / 16)– 256 Mb	(16 / 16)– 512 Mb	
	State Clock Rate (Synchronous, External Clock)	150 MHz			200 MHz	
Storage		Conventional Timing, Transitional Timing				
Channel to channel skew		< 1ns				
Threshold	Group	1 (CH0~7 & CKI)	2 (CH0~7 & CKI, CH8~15)			
	Range	+20V ~ -20V				
	Resolution	50mV				
	Accuracy	±100mV + 5%*Vth				
Input Voltage	Non-Destructive	Over +/-42V DC & AC				
	Operation (Normal/High Division)	-20V ~ +20V / -10V ~ +10V				
	Sensitivity (0.5/0.75/1 Vpp)	100 MHz / 120 MHz / 150 MHz		180 MHz / 200 MHz / 220 MHz		
	H/W Schmitt (On/Off)	560 mV / 80 mV				
Impedance		1 mΩ / 2 pF				
Temperature	Operating / Storage	5 °C~45 °C (41 °F~113 °F) / -10 °C~65 °C (14 °F~149 °F)				
I/O port	Trig-In	TTL 3.3V (Rising / Falling)				
	Trigger pulse approval	> 8 ns				
	Trig-Out	TTL 3.3V, Pulse Width				
	Ref. Clock Input	10MHz, Vpp=3.3 to 5V				
	Ref. Clock Output	10MHz, TTL 3.3V				
	Connector type	MCX jack / female				
Trigger	Resolution	500ps				
	Channels	8	16			
	States	16				
	Events	16				
	Pre / Post	Yes				
	Pass Counter	Yes (0~1048575 times)				
	Digital	Channel, Pattern, Single / Multi Level, Width, Time-out, External				
	Analog	Rising / Falling				
	Bus I	I2C, SPI, UART				
Bus II	---	BiSS-C, CAN2.0B/CAN FD, DP_Aux ¹ , HID over I2C, I2S, LIN2.2, USB PD 3.0				

	Bus III	---	DALI, I3C, LPC, MDIO, Mini/Micro LED, MIPI RFFE, MIPI SPMI 2, Modbus, PMBus, Profibus, SMBus, SVI2, USB1.1
	Bus IV	---	eMMC 4.5, eSPI, MII, RGMII, RMII, SVID ³ , SD 2.0 (SDIO 2.0), Serial Flash (SPI NAND)
Protocol Analyzer	I	I2C, SPI, UART	
	II	---	BiSS-C, CAN2.0B/CAN FD, DP_Aux ¹ , HID over I2C, I2S, LIN2.2, USB PD 3.0
	III	---	DALI, I3C, LPC, MDIO, Mini/Micro LED, MIPI RFFE, MIPI SPMI 2, Modbus, PMBus, Profibus, SMBus, SVI2, USB1.1
	IV	---	eSPI, MII, RGMII, RMII, SVID ³
Software Features	Power Sequence	---	Input setup .CSV file for Timing Sequence and H/W Strap check.
	Measurement	Digital or Analog waveforms	
	Zoom / Report Window	YES	
	Note editor	Edit notes on Waveform Window	
	Quick Bus Decode Setup	YES	
	Trigger / Auxiliary cursors	1/25	
	Data Logger	Saved to Hard Disk Drive	
	Bus Decode	1-Wire, 3-Wire, 7-Segment, A/D Mux Flash, AccMeter, ADC, APMPL, AVSBus, BiSS-C, BSD, BT1120, CAN 2.0B/FD, Close Caption, CODEC_SSI, DALI, DMX512, DP_Aux ¹ , EDID, eMMC 5.1/MMC, eSPI, FlexRay, HD Audio, HDLC, HDQ, HID over I ² C, I ² C, I ² C EEPROM, I ² S (PCM, TDM), I3C, IrDA, ITU-R BT.656 (CCIR656), JTAG, JVC IR, LCD1602, LED_Ctrl, LIN 2.2, Line Decoding, Line Encoding, Lissajous, LPC, LPT, Math, M-Bus, MDDI, MDIO, MHL CBUS, Microwire, Mini/Micro LED, MIPI CSI LP, MIPI DSI LP, MIPI RFFE, MIPI SPMI 2.0, Modbus, NEC IR, PECEI 3.0, PMBus, Profibus, PS/2, PWM, QEI, QI, RC-5, RC-6, S/PDIF, SD 2.0 (SDIO 2.0), Serial Flash, Serial IRQ, SGPIO, Smart Card, SMBus (SBS, SPD), SMI, SoundWire, SPI, SPI-NAND, SSI, ST7669, SVI2, SVID ² , SWD, SWIM, SWP, UART, ULPI, UNI/O, USB 1.1, USB PD 3.0, Wiegand, ...	
	Line Decoding	Biphase Mark, Differential-Manchester, Manchester (Thomas, IEEE802.3), Miller, Modified Miller, NRZI, ...	
	Line Encoding	AMI(Standard, B8ZS, HDB3), Biphase Mark, CMI, Differential-Manchester, Manchester (Thomas, IEEE802.4), MLT-3, Miller, Modified Miller, NRZI, Pseudoternary, ...	
Dimension	L x W x H (mm ³)	123 x 76 x 21(mm ³)	
Lead Cable	Data / CLK / NC / GND	8 / 1 / 8 / 23	16 / 1 / 0 / 23
Grippers		10	20
Stack Cable	MCX to MCX (30cm)	1	2

¹Optional DP AUX adapter needed.

² Upon request ONLY by users who have signed CNDA with Intel, SVID decode supported by all MSO models

³ Upon request ONLY by users who have signed CNDA with Intel, SVID trigger & PA supported by MSO2216B / B+ ONLY.

Specification Table (International & Microchip)

International		MSO2008W	MSO2116W	MSO2116B	MSO2216B	MSO2216B+
Microchip		MSO2008N	MSO2116N	MSO2116M	MSO2216M	MSO2216M+
Power	Power Source	USB bus-power (+5V)				
	Static Power Consumption	0.9W				
	Max Power Consumption	< 3.9W	< 6W			
Interface		USB3.0				
Channel (Data / Clock / Ground)		8 / 1 / 23	16 / 1 / 23			
Total Memory		2Gb	4Gb		8Gb	
Analog Input	Channels	Group I (CH0~7)	Group I, II (CH0~7, CH8~15)			
	Sample Rate (Group I or II)	200MHz / 1CH, 100MHz / 2CH, 25MHz / 8CH				
	Sample Rate (Group I or II)	The minimum value of Group I or II settings				
	Bandwidth	40MHz				
	ADC Bits	12				
Digital Input	Timing Analysis (Asynchronous)	Available channels (Conventional / Transitional Timing) - Memory per channel				
	2 GHz	(4 / 3)- 512 Mb	(4 / 3)- 1 Gb	(8 / 7)- 512 Mb	(8 / 7)- 1 Gb	
	1 GHz	(8 / 6)- 256 Mb	(8 / 6)- 512 Mb	(16 / 14)- 256 Mb	(16 / 14)- 512 Mb	
	500 MHz	(8 / 6)- 256 Mb	(16 / 12)- 256 Mb	(16 / 16)- 256 Mb	(16 / 16)- 512 Mb	
	250 MHz and lower	(8 / 6)- 256 Mb	(16 / 16)- 256 Mb	(16 / 16)- 256 Mb	(16 / 16)- 512 Mb	
	State Clock Rate (Synchronous, External Clock)	150 MHz			200 MHz	
Data Storage	Conventional Timing, Transitional Timing					
Channel to channel skew		< 1ns				
Threshold	Group	1 (CH0~7 & CKI)	2 (CH0~7 & CKI, CH8~15)			
	Range	+20V ~ -20V				
	Resolution	50mV				
	Accuracy	±100mV + 5%*Vth				
Input Voltage	Non-Destructive	Over +/-42V DC & AC				
	Operation (Standard / High Resolution)	-20V ~ +20V / -10V ~ +10V				
	Sensitivity (0.5/0.75/1 Vpp)	100 MHz / 120 MHz / 150 MHz		180 MHz / 200 MHz / 220 MHz		
	H/W Schmitt (On/Off)	560 mV / 80 mV				
Impedance		1 MΩ / 2 pF				
Temperature	Operating / Storage	5 °C~45 °C (41 °F~113 °F) / -10 °C~65 °C (14 °F~149 °F)				
I/O port	Trig-In	TTL 3.3V (Rising / Falling)				
	Trigger pulse approval	> 8 ns				
	Trig-Out	TTL 3.3V, Pulse Width				
	Ref. Clock Input	10MHz, Vpp=3.3 to 5V				
	Ref. Clock Output	10MHz, TTL 3.3V				
	Connector type	MCX jack / female				
Trigger	Resolution	500ps				
	Channels	8	16			
	States	16				
	Events	16				
	Pre / Post	Yes				
	Pass Count	Yes (0~1048575 times)				
	Digital	Channel, Pattern, Single / Multi Level, Width, Time-out, External				

	Analog	Rising / Falling	
	Bus I	I2C	
	Bus II	---	CAN 2.0B/CAN FD, LIN2.2, SPI, UART (RS232)
	Bus III	---	BiSS-C, DALI, DP_Aux ¹ , HID over I2C, I2S, I3C, LPC, MDIO, Mini/Micro LED, MIPI RFFE, MIPI SPMI 2, Modbus, PMBus, Profibus, SMBus, SVI2, USB1.1, USB PD 3.0
	Bus IV	---	eMMC 4.5, eSPI, MII, RGMII, RMII, SVID ³ , SD 2.0 (SDIO 2.0), Serial Flash (SPI NAND)
Protocol Analyzer	I	I2C	
	II	---	CAN 2.0B/CAN FD, LIN2.2, SPI, UART (RS232)
	III	---	BiSS-C, DALI, DP_Aux ¹ , HID over I2C, I2S, I3C, MDIO, MIPI RFFE, Modbus, PMBus, Profibus, PWM, SMBus, USB1.1, USB PD 3.0
	IV	---	eSPI, MII, RGMII, RMII, SVID ³
Software Features	Power Sequence	---	Input setup .CSV file for Timing Sequence and H/W Strap check.
	Measurement	Digital or Analog waveforms	
	Zoom / Report Window	YES	
	Note editor	Edit notes on Waveform Window	
	Quick Bus Decode Setup	YES	
	Trigger / Auxiliary cursors	1/25	
	Data Logger	Saved to Hard Disk Drive	
	Bus Decode	1-Wire, 3-Wire, 7-Segment, A/D Mux Flash, AccMeter, ADC, APML, AVSBus, BiSS-C, BSD, BT1120, CAN 2.0B/FD, Close Caption, CODEC_SSI, DALI, DMX512, DP_Aux ¹ , EDID, eMMC 5.1/MMC, eSPI, FlexRay, HD Audio, HDLC, HDQ, HID over I ² C, I ² C, I ² C EEPROM, I ² S (PCM, TDM), I3C, IrDA, ITU-R BT.656 (CCIR656), JTAG, JVC IR, LCD1602, LED_Ctrl, LIN 2.2, Line Decoding, Line Encoding, Lissajous, LPC, LPT, Math, M-Bus, MDDI, MDIO, MHL CBUS, Microwire, Mini/Micro LED, MIPI CSI LP, MIPI DSI LP, MIPI RFFE, MIPI SPMI 2.0, Modbus, NEC IR, PECL 3.0, PMBus, Profibus, PS/2, PWM, QEI, QI, RC-5, RC-6, S/PDIF, SD 2.0 (SDIO 2.0), Serial Flash, Serial IRQ, SGPIO, Smart Card, SMBus (SBS, SPD), SMI, SoundWire, SPI, SPI-NAND, SSI, ST7669, SVI2, SVID ² , SWD, SWIM, SWP, UART, ULPI, UNI/O, USB 1.1, USB PD 3.0, Wiegand, ...	
	Line Decoding	Biphase Mark, Differential-Manchester, Manchester (Thomas, IEEE802.3), Miller, Modified Miller, NRZI, ...	
Line Encoding	AMI(Standard, B8ZS, HDB3), Biphase Mark, CMI, Differential-Manchester, Manchester (Thomas, IEEE802.4), MLT-3, Miller, Modified Miller, NRZI, Pseudoternary, ...		
Dimension	L x W x H (mm3)	123 x 76 x 21	
Lead Cable	Data / CLK / NC / GND	8 / 1 / 8 / 23	16 / 1 / 0 / 23
Grippers		10	20
Stack Cable	MCX to MCX (30cm)	1	2

¹ Optional DP AUX adapter needed.

² Upon request ONLY by users who have signed CNDA with Intel, SVID decode supported by all MSO models

³ Upon request ONLY by users who have signed CNDA with Intel, SVID trigger & PA supported by MSO2216B / B+ ONLY.

Chapter 2 Function list and operation

Protocol Analyzer

File

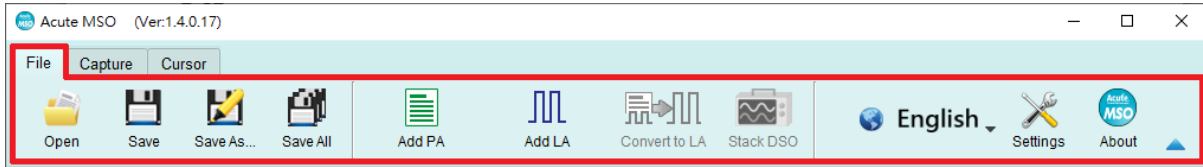

Open file: Load the file



Save file: Save the current window to file



Save as: Save with a new file name with specified storage range



Save all: Save all Protocol Analyzer/Logic Analyzer windows to files



Add Protocol Analyzer: Add a Protocol Analyzer window



Add Logic Analyzer: Add a Logic Analyzer window



Convert to Logic Analyzer: When the “show waveform” capture mode is enabled; you can click this function to transfer the waveform and setting parameters into the Logic Analyzer window and continue to use the Logic Analyzer window to capture Protocol.

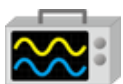

Stack Oscilloscope: You may stack a DSO to become a MSO under the Protocol Analyzer mode. But you must choose the “show waveform” capture mode to capture the protocol data with the waveforms. Then, click the DSO icon to enter the Logic Analyzer window.



Language: Display language. You can select English, Traditional Chinese, or Simplified Chinese



System environment settings: Here you can set the working directory, the label height, whether to load the last setting, the waveform display mode and its color

Capture

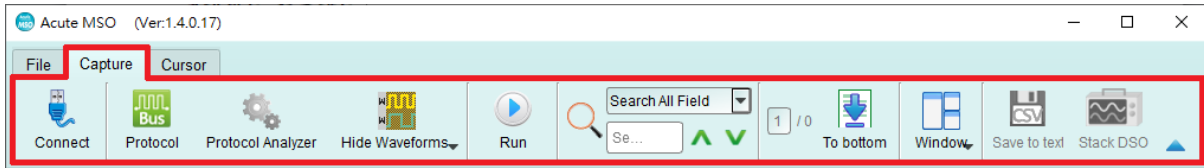

Protocol Settings



Style 1 for those protocols with easy setting

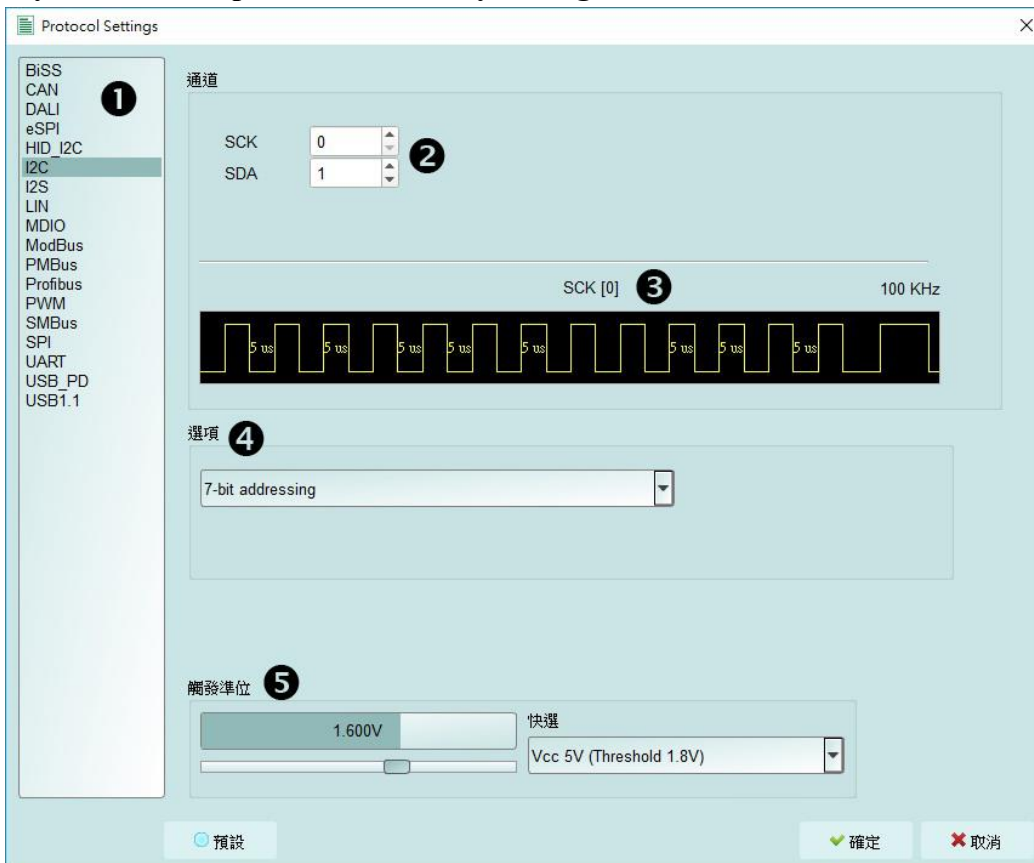

1. **Select the Protocol**
2. **Channel setting**
3. **Waveform Preview:** The signal's waveform and frequency are automatically detected.
4. **Options:** 可 You can set the capture and decoding parameters for Protocol
5. **Threshold:** It can be set according to the voltage level of the signal.

Style 2 for those protocols needs more setting

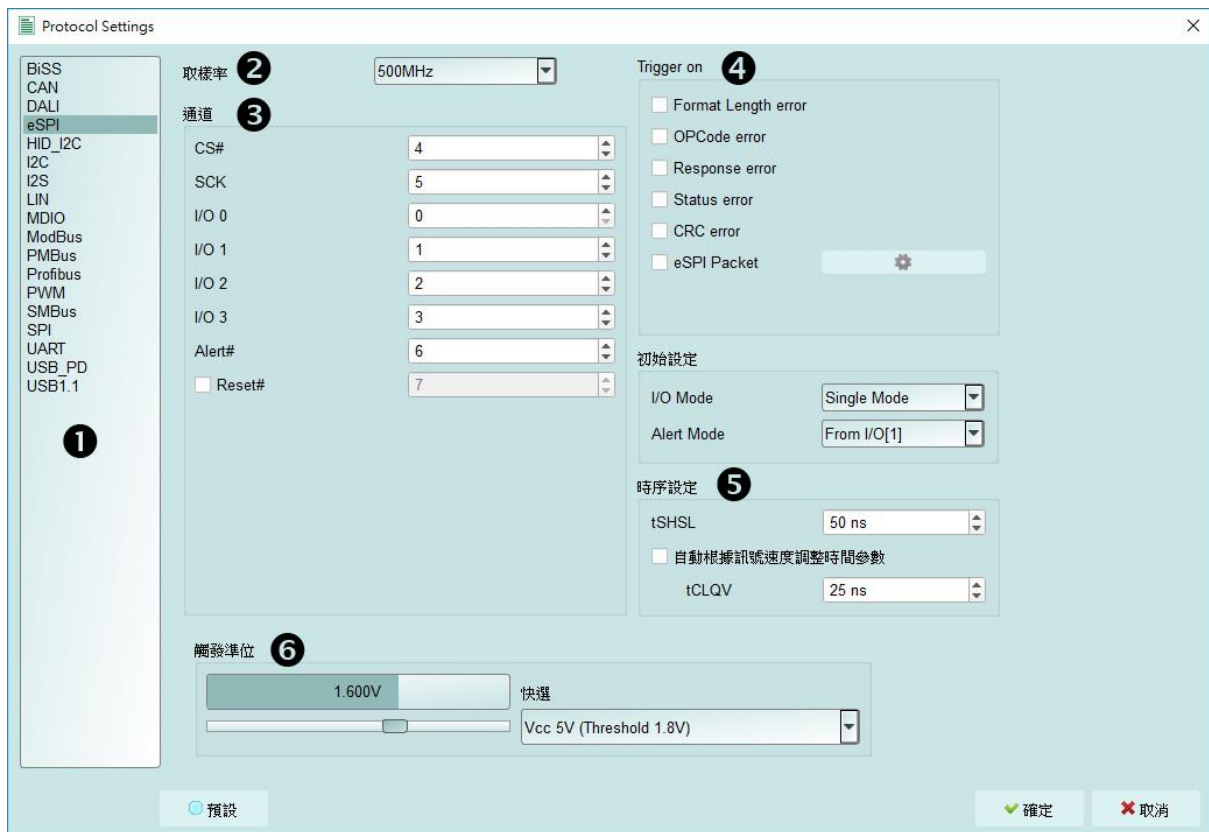

1. **Select the Protocol**
2. **Set the Sample Rate**
3. **Channel setting**
4. **Trigger on**
5. **Options:** You can set the capture and decoding parameters for Protocol.
6. **Threshold:** It can be set according to the voltage level of the signal.

Operating mode and memory setting

There are three modes for operating mode and memory setting ()

Mode 1 Protocol Analyzer

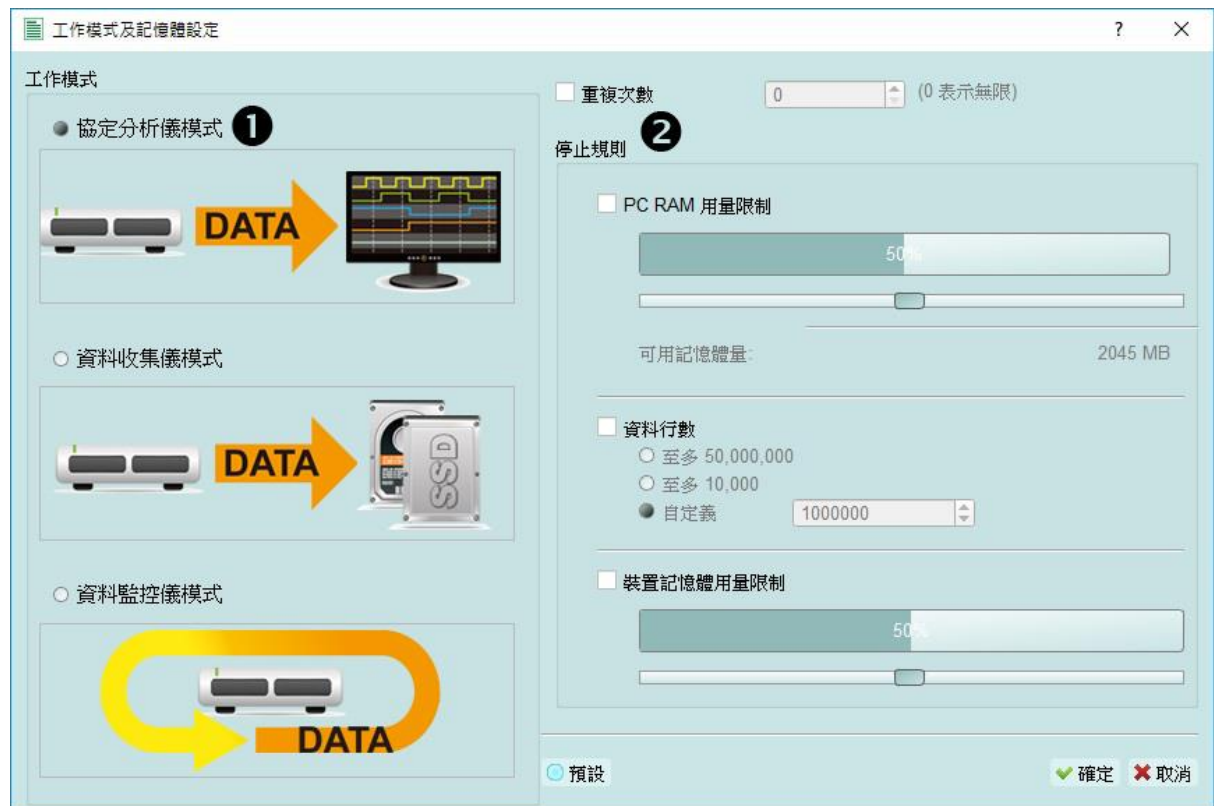

Functional description

Captured data will be sent back to the PC for real time display. You can immediately see the protocol data right away.

Rule:

1. Data can be seen immediately.
2. If the amount of captured data is not big, you do not have to set the amount of memory.

Notice for use:

As data will be captured and displayed at the same time the performance requirement for the USB and the computer will be higher. If the computer cannot handle the data in time, the device may automatically stop due to full memory.

If software is in operation during the capture period the computer will respond more slowly.

- **Rules for repetitive times and automatic stop**

Repetitive Times

- If it is not enabled, the device will be stop ped after the stop condition matched.
- If it is enabled, the device will be stop ped after the stop condition matched, then save the captured data and repeat the captures again, according to the number of captures that has been set.
- If the number of captures is set at 0, the device will capture data repetitively.

Three **Stop Conditions** to stop the device automatically are provided as follows:

- **Maximum PC RAM Limit**

Stop the capture when the stored data size matched the size of allocated PC RAM, this limitation will avoid excessive use of the PC RAM, which may resulting in insufficient memory and unstable performance of the operating system.

- **Number of Data Lines**

Stop the capture when the stored data line number matched the setup data line number, you can select this function if you need only sufficiently number of data lines without capturing data for a long time. This function is set to OFF by default.

- **Maximum Device Memory Limit**

Stop the capture when the device memory is filled to the set condition.

Mode 2 Protocol Logger



Functional description:

Data will be sent back to the PC for saving without being processed and displayed. Only after the user presses to stop the operation will data begin to be processed and displayed.

Rule:

1. As long as the hard disk is big enough to respond quickly enough, it can save a great amount of data.
2. Logger file (.LOG) can be opened for Analyzer later, no need to analyze them right after their capture

Notice for use:

1. Performance requirements for the USB and the computer (hard disk) are high.
2. Due to the large amount of logger data, the requirements for the hard disk space and the time for follow up Analyzer will be very great.

• Run data process after capture stopped

Check this option to process the data after Logger capture stopped, or the software

will only save the logger data without analyzing process.

Run data process after capture stopped

You can reload the .LOG file from Load file to reanalyze the data.

MSO files (*.MSW | *.LOG) ▾

Whether you check the results immediately or load them into the file, the file name will be converted from LOG to BFW.

Mode 3 Protocol Monitor

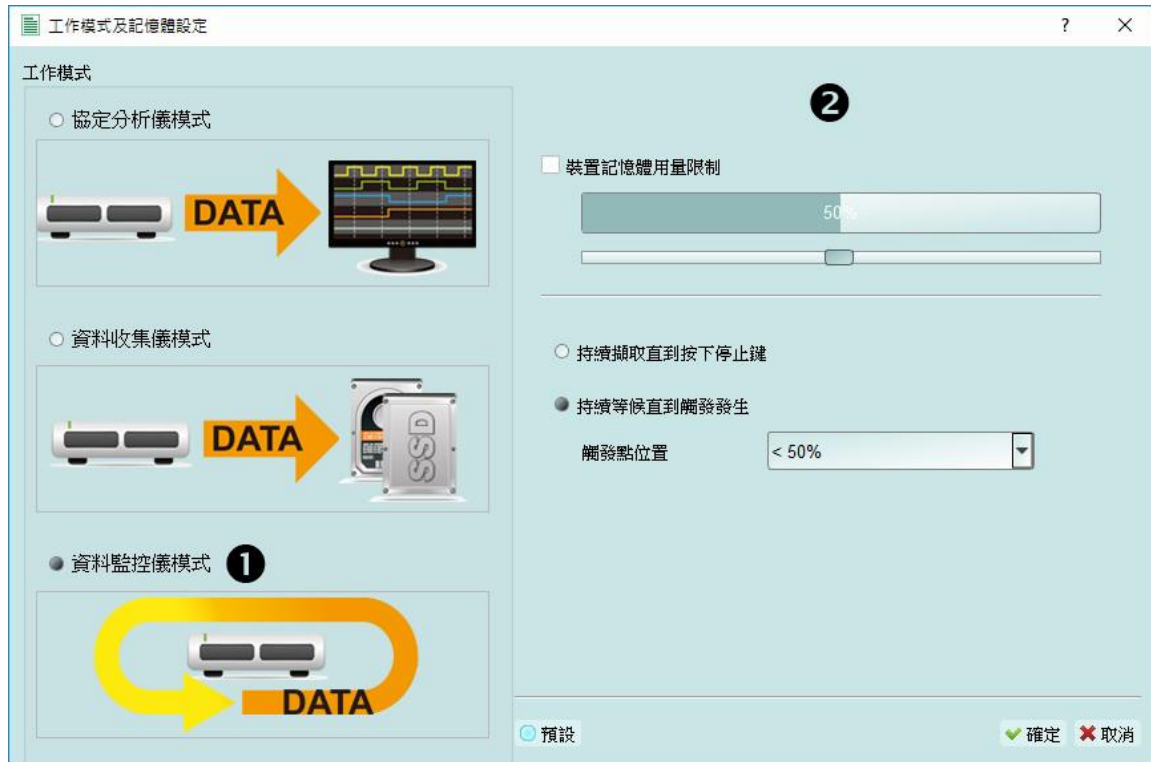

Functional description

Data will be kept in the device and overwrote the old data without returning to the PC, the capture can be stopped by user manually or by trigger condition matched, then the device will fill the device memory until memory full and return to PC for display.

Rule:

1. During the capture period, data are not returned to the PC, reducing the performance requirements on the USB and the computer.
2. The total amount of data is the total amount of device memory.
3. Trigger conditions can be set and monitored for a long time Device memory will be filled only when the amount of data matches the trigger conditions.

Notice for use:

1. If the trigger is not set or you have set the trigger but want to retrieve the data before the memory is full, you must manually press “Stop” to send data back to the computer.

- **Work options**

- Maximum Device memory limit

If the checkbox is unchecked, the max memory of the device is used.

If the checkbox is checked, the usage ratio of the device memory can be adjusted; less memory can shorten the subsequent processing time.

- Data capture will continue until "Stop" is pressed (Wait for stop)

Data capture will continue. If memory is full the new data will be still captured to replace the old data, until "Stop" is pressed Then the newest data will be sent back to the computer.

- Data capture will continue until the trigger condition is met (Wait for Trigger)

If the trigger condition is not set, there will be no Pre/Post Trigger relationship and only the Capturing will be shown until the device memory is full. If the trigger condition is set, data will be filled according to the set Trigger Position. Data capture will continue until the trigger condition is met or "Stop" is pressed Then, data capture will stop and the set memory will be filled.

Show Waveforms



If “Show Waveforms” is selected, the device will capture the waveform data, but show the waveforms only after the capture stops. Selection of Show Waveforms will take up more device memory.

When “Show Waveforms” is enabled, the waveform area will provide the following functions:



1. Bus Decode 

Press this button to refresh the bus decode.

2. Stop the bus decode 

This button can stop the bus decode right away.

3. Add User Notes 

4. Waveform zoom in/out  

This button can scale up or down the waveforms, but it is recommended to use the mouse cursor to zoom the waveforms in or out for your convenience.

Search

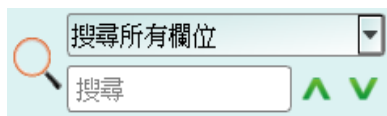

Search function can search data in the report window.

1. Enter the search text

A mark will appear in front of their data meeting the search criteria. 

2. Search the previous piece / the next piece of data.
3. Specify all fields or target fields for search.

Specify fields for search can reduce the search range, thus speeding up the search.

In actual search, the searched data will be shown in green background color together with the total number of packets found. 'CMD' 5556 Packets found If no data is found, the search result will be shown in orange Search text 'CMD99' not found! background color.

To the end



When viewing data, you press this button to move directly to the last end of data. If you press this button while the device is capturing data, the most up to date data will be displayed.

Window



Select to enable/disable multiple display lists, such as: Search List, Statistic List ...etc.

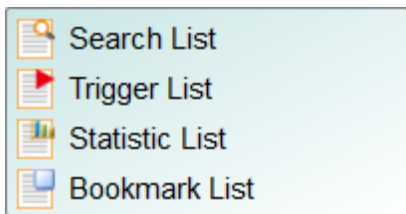

Line No.	Timestamp	Status	Address	RW	Data
2	0.000.155.560 0	Start	12*	Wr	10* 20* 30*
5	0.001.017.660 287.08us	Start	12*	Wr	10* 20* 30*
8	0.001.879.760 287.08us	Start	12*	Wr	10* 20* 30*
11	0.002.741.860 287.08us	Start	12*	Wr	10* 20* 30*
14	0.003.603.980 287.10us	Start	12*	Wr	10* 20* 30*

1. Select to display different display list.
2. Use the control buttons to move the current position, or input row number to jump to specified row.
3. Use the control buttons to add /remove selected row to Bookmark List.

Saved as text file



Contents of the report may be saved as .TXT or .CSV.

Save options:

1. You can select to save the data as a file or according to the number of rows.
2. Advanced reports

If detailed data should be saved in the protocol Analyzer, you should tick this option.

Detail window

Many Protocols are equipped with a large number of numerical data, which cannot be appropriately displayed all together in the report window. Therefore, you can use the mouse to click the Data field on the report window to display the data in the detail window.

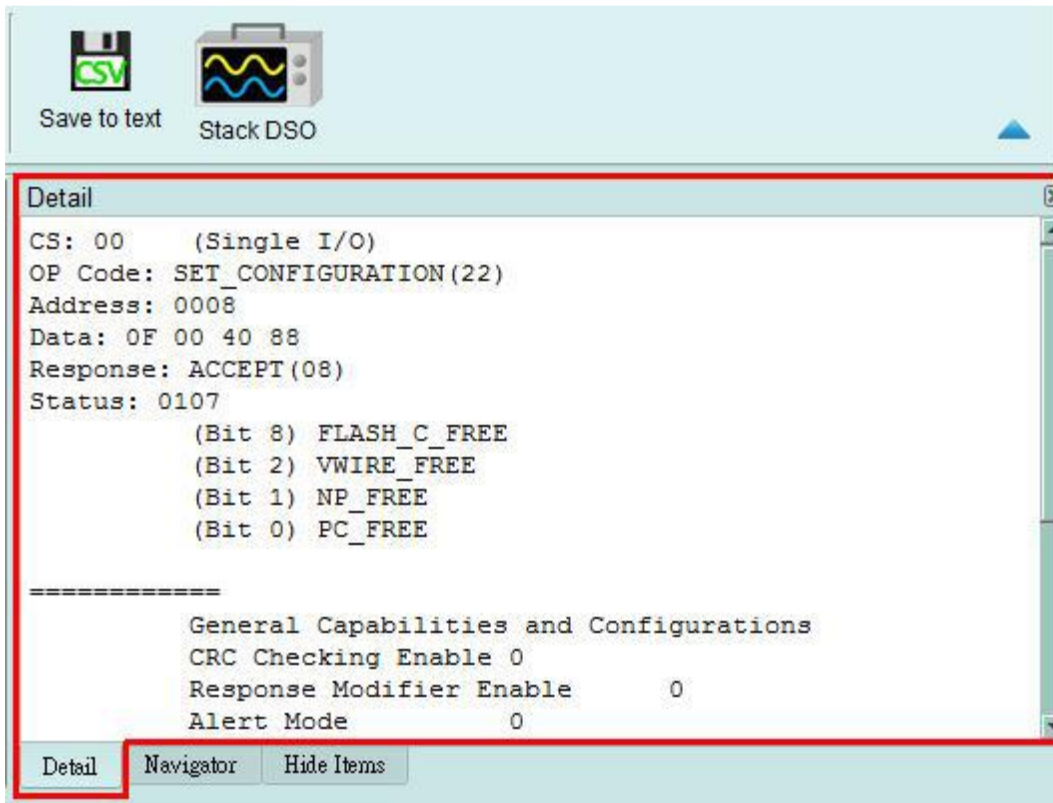

Statistics window

Data statistics are made according to the different characteristics of Protocols, so as to facilitate the understanding of the entire transmission situation, you may also click on the

statistic trace to summarize all records of the selected trace into the statistic list window.

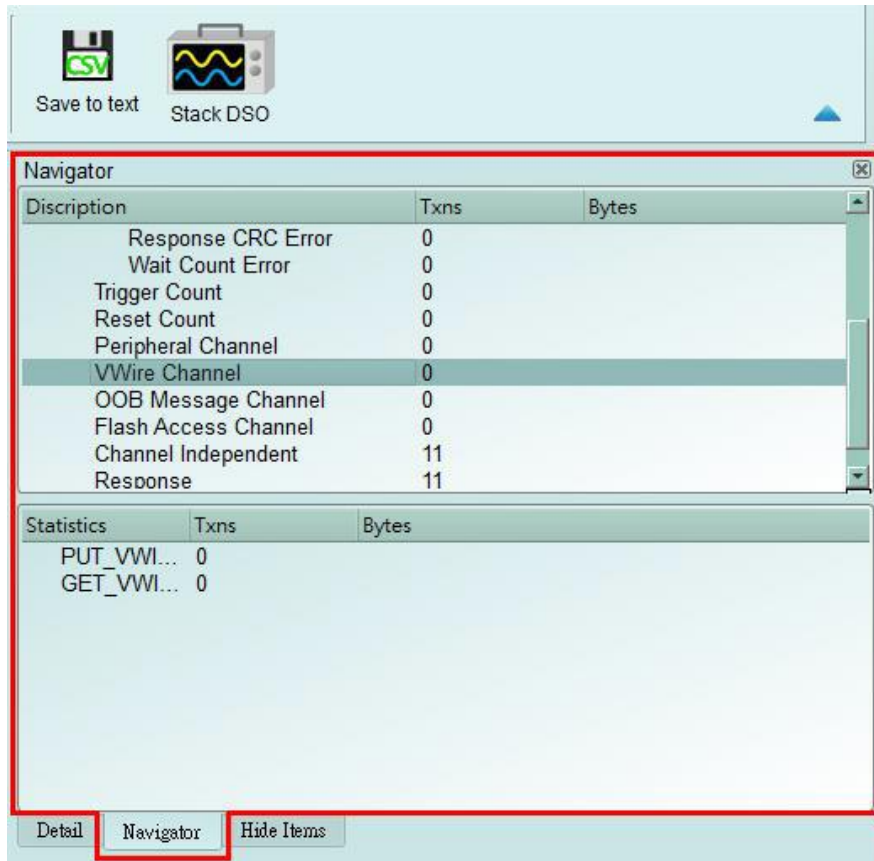

Hide Data window

In this screen, you can select to hide the data items. Software is used in this function to hide data and to restore the data as long as you click the “Clear” button.

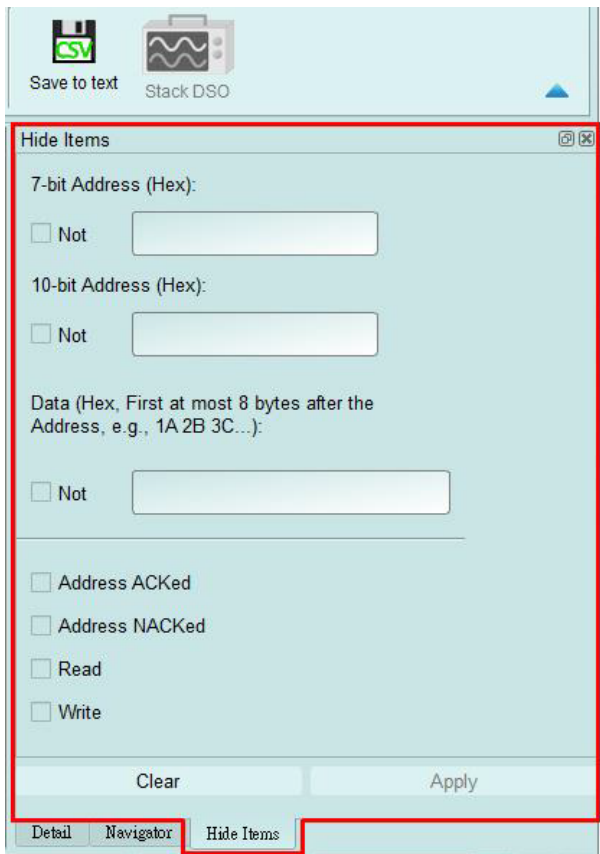

Stack Oscilloscope

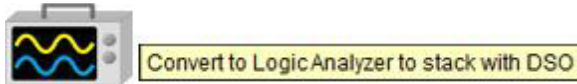

The stack oscilloscope can only be enabled in the Logic Analyzer mode. If you want to enable the stack oscilloscope in the protocol Analyzer mode, you must first press the "Convert to Logic Analyzer and Stack Oscilloscope" button to switch to the Logic Analyzer mode to enable this function. It should be noted that you must open Show Waveforms in the Protocol Analyzer mode and capture the data/waveform to switch.

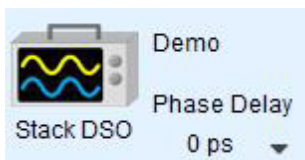

Cursor

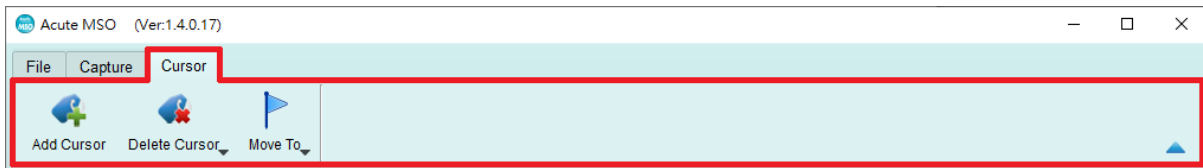

This function includes the cursor setting and the waveform search function matching the cursor.





Logic Analyzer Window



1. **Toolbar:** Including trigger, sampling rate, threshold and other capture parameters.

2. **Channel Label:** You can use the icon ( ) below to add and delete the channel.

Pressing mouse left button on the channel label to change the channel parameter settings; Click the gear button on the top right corner of the Bus channel to change the advanced parameter settings; Select and drag a channel label to another channel label to combine two or more channel labels.

3. **Report Window Toolbar:** In the report window, you can choose to display the channel data ( ) or decode result () , waveform statistics () , and report the result as .CSV and .TXT output () .

4. **Status Bar:** Connection status of the device is displayed.

5. **Info:** Display channel, Value and Trigger information, can be selected to Show/Hide in Environment settings.

6. **Waveform Area:** Mouse wheel can be used to zoom in/out the waveform scale; press

Shift + Key to place cursors to calculate the time interval or frequency. Please refer to the cursor section below for the cursor usage.

File

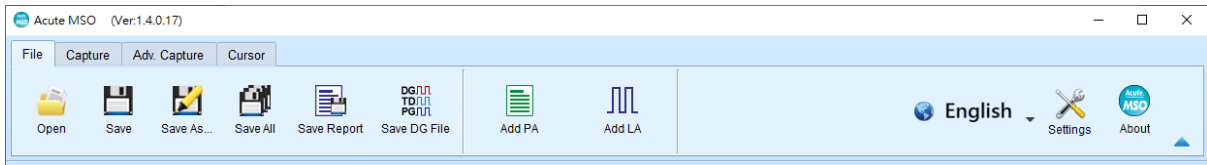

Open file: Load the file



Save file: Save the current file



Save as: Save with a new file name and may set the storage range



Save all: Save all files at once



Save report: Save the bus decode report



Save Analog Data: Save MSO captured analog data to .CSV or .TXT file.

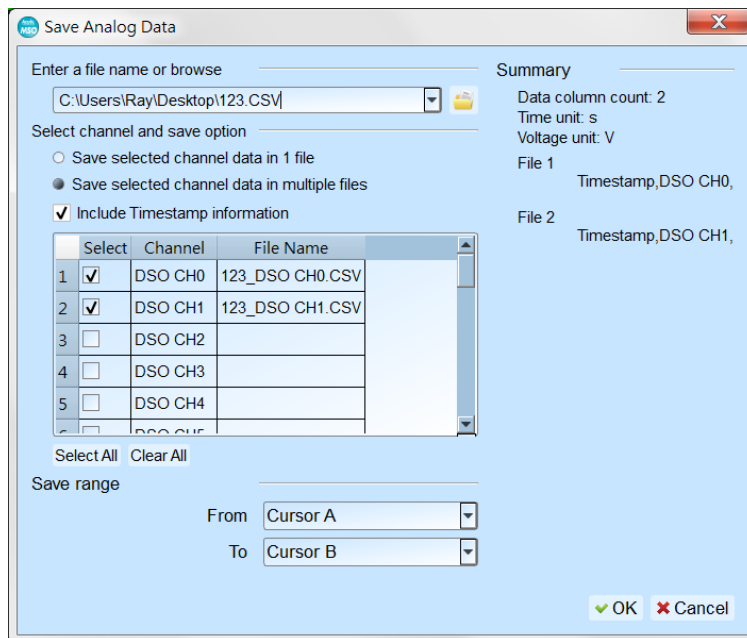

Store the captured analog data into text format file, the available options are:

1. Save selected channel data in 1 file: The analog data will be stored into 1 file, data of each channel will be separated by “comma”.

2. Save selected channel data in multiple files: The analog data of each channel will be stored into individual files respectively with user input file name appended with channel name.
3. Include Timestamp information: Choose to store the Timestamp information into the first column of each file, the Timestamp information will be stored with time unit: second.
4. Data selection list: Select channels need to be stored, the list will also show data store column or file name at the 3rd column of the list if the channel is selected for output.
5. Save Range: Choose to change the data save range.



Saved as a DG file:

Convert captured waveform to DGW format for the Acute Digital Data Generator(PKPG、PG2000、DG3000、TD3000), which can be used to resend the digital signals.

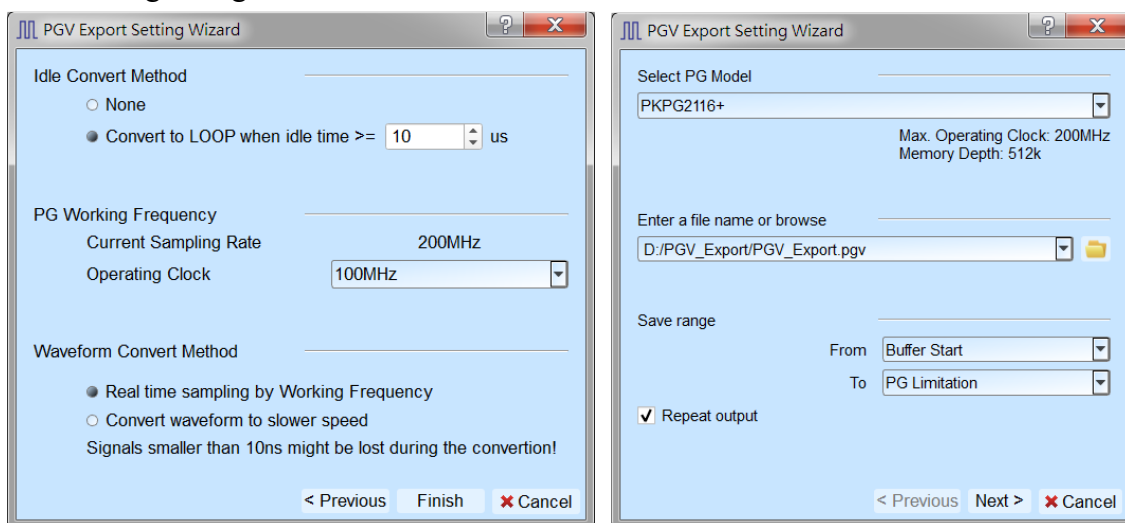

1. Select DG/PG Model: The software will check the maximum working frequency and memory depth according to the selected DG/PG model.
2. Enter a file name or browse
Enter a file name and directory to save the converted DGW/PGV file.
3. Save range:
Select the waveform range to convert to DGW/PGV file, you may select either waveform within cursor range, or select maximum available range according to DG/PG's maximum memory. (Exported file size larger than DG/PG's maximum

memory may not be opened by the DG/PG's software.)

4. Repeat output:

Check to add "Jump to start" command at the end of DGW/PGV file.

5. Idle Convert Method

Select to replace signal pulse width greater than specified time to a short block of waveform with Loop instructions to save the DG/PG's memory. (The waveform will become more complicated and not easy to read/edit after enable this option)

6. DG/PG Working Frequency:

Specify the DG/PG working frequency.

7. Waveform Convert Method

When the LA's sampling frequency is faster than the DG/PG's working frequency, the software provides two different ways to convert the DGW/PGV wave form, one is the real time sampling mode with DG/PG's maximum working frequency (Small signal might be lost during the conversion), the other is convert the original high speed waveform to slower DGW/PGV waveform (Slower signal speed might introduce some signal timing issue since the setup/hold time will also be changed)



Add Protocol Analyzer: Add a protocol Analyzer window



Add Logic Analyzer: Add a logic Analyzer window



Language: Display language. You can select English, Traditional Chinese, or Simplified Chinese



System environment settings: Here you can set the working directory, the label height, whether to load the last setting, the waveform display mode and its color.

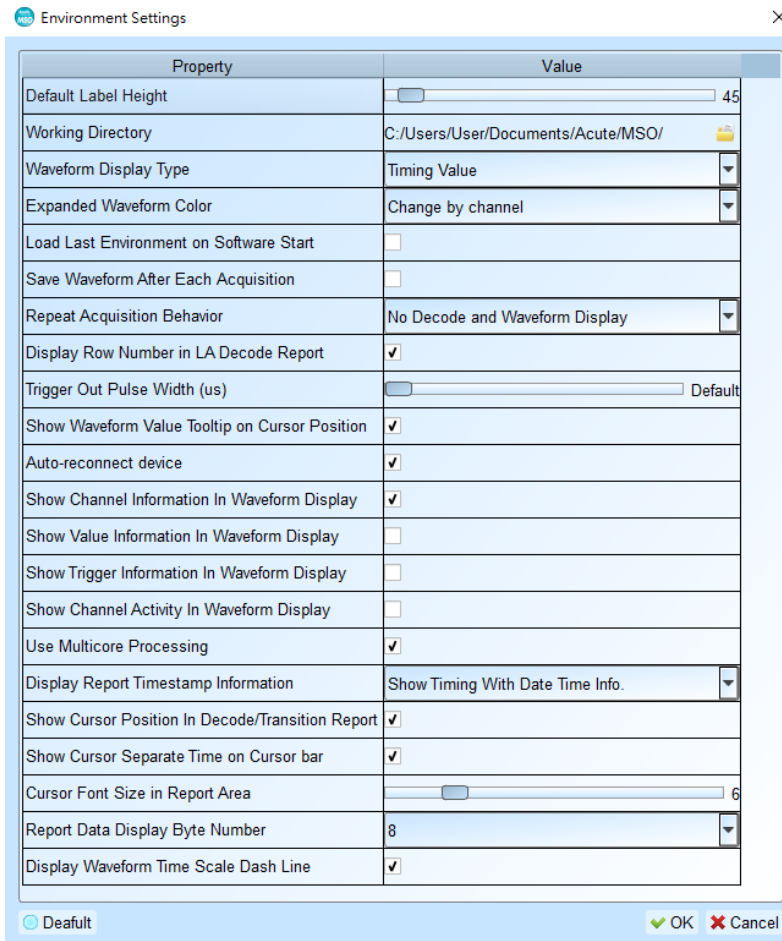

1. Default Label Height: The channel height of the waveform area can be modified.
2. Working Directory: Where the staging content/repeatedly fetched waveforms are stored when the software is in operation.
3. Waveform Display Type: What is displayed between waveform edge changes, optional time between grid/logical values/not displayed.
4. Expanded waveform color: You can choose whether the colors are different between converged channels.
5. Load Last Environment on Software Start: When the software starts, it will automatically load the setting values that were previously closed, and the archive waveforms will not load.
6. Save Waveform After Each Acquisition: this archive is stored in the working directory.
7. Repeat Acquisition Behavior: Whether to display waveform decoding, to display,

- optional must show seconds (1/2/5, unit: s).
8. Display Row Number in LA Decode Report: The number of rows will be added to the left of the reporting area timeline.
 9. Trigger Out Pulse Width (us): The default length is triggered until the end of fetching. The following 2 items will be controlled by the cursor, which will display the contents of the "Select Cursor", which can be set in the waveform area shift and A-Z, and moved to the cursor position by pressing A-Z (T is the trigger point mark, not available).
 10. Show Channel Information In Waveform Display: Show using channel numbers, and flow row analysis will display additional names.
 11. Show Value Information In Waveform Display: the digital channel displays 0/1, and the analog channel displays the voltage value.
 12. Show Trigger Information In Waveform Display: Set trigger point value.
 13. Show Channel Activity In Waveform Display: Count the kinds of changes that the channel takes in this time.
 14. Use Multicore Processing: Use multi-core to speed up data processing.
 15. Display Report Timestamp Information: Includes the time format of the date / general time format (trigger point is 0 seconds) / number of sampling points.
 16. Show Cursor Position In Decode/Transition Report: Show cursor position in the report area time field.
 17. Show Cursor Separate Time on Cursor bar: Add additional time between cursors on the horizontal timeline of the waveform area.
 18. Cursor Font Size in Report Area: Cursor font size for item 13.
 19. Report Data Display Byte Number: This is an item set for protocol analyzer mode, and you can modify the report field to show the number of Bytes.
 20. Display Waveform Time Scale Dash Line: Add dashed lines to the waveforms in the reporting area for easy comparison with the timeline.

Capture

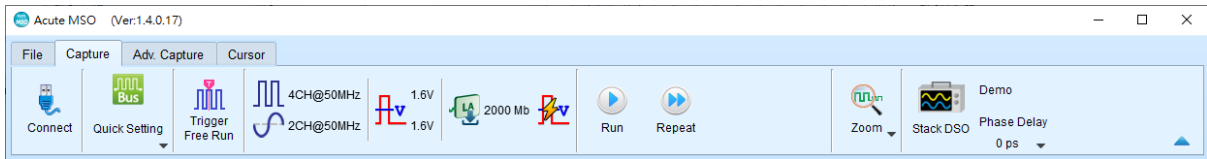

Quick Settings



Required channels and related settings can be established quickly. If you specify to establish the bus decodes, the sampling rate and threshold will be set according to the default conditions.

Trigger Parameter Setting



• Manual Trigger

After setting up, Click “Stop” button for positioning trigger point

• Single Level Trigger

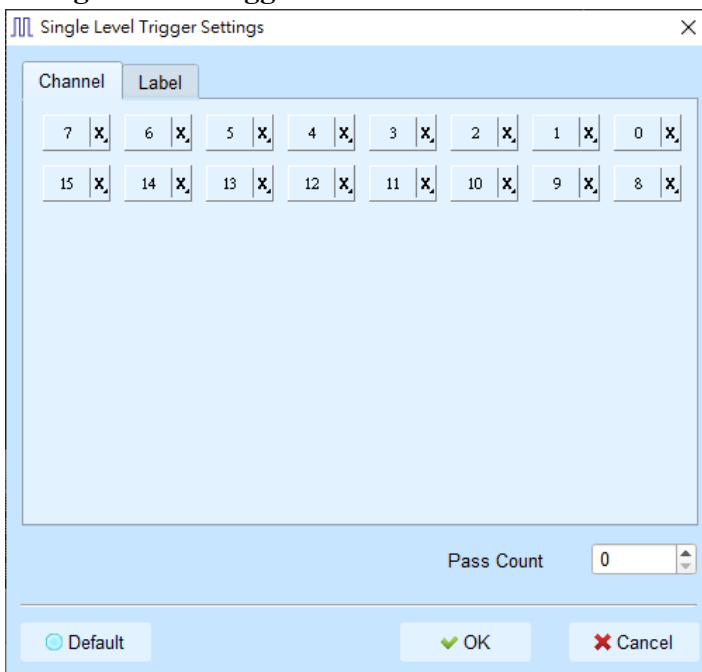

1. **Channel/Label:** You can select Don't care(X) 、 Rising Edge(↑) 、 Falling

Edge(↓)、Low(0)、High(↑)、Either() or specified Value as trigger conditions.

- Pass Count:** The number of triggering signals that match the trigger parameters is ignored. It is preset as 0 by default to indicate that it is not ignored.

• **Multi Level Trigger**

Multi Level triggering is composed of multiple single-stage trigger conditions. This function can have up to 16 states, each of which must be set separately and set in the same way as the single level trigger. When adding a new state, you can press the button on the top to select the relationship between each state. The relationship between each state can be a continuous trigger (Next IF) or a non-continuous trigger (Then IF).

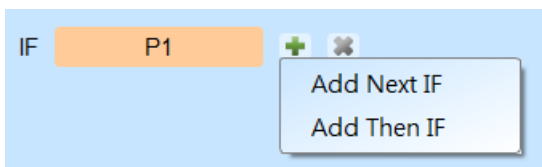

- Schematic diagram of the current set of trigger conditions**
- Trigger conditions setting**

As shown in the following diagram, the first and the second classes are continuous trigger, the relationship between the second and third classes are non-continuous trigger, and the third, fourth, fifth and sixth classes are continuous trigger.

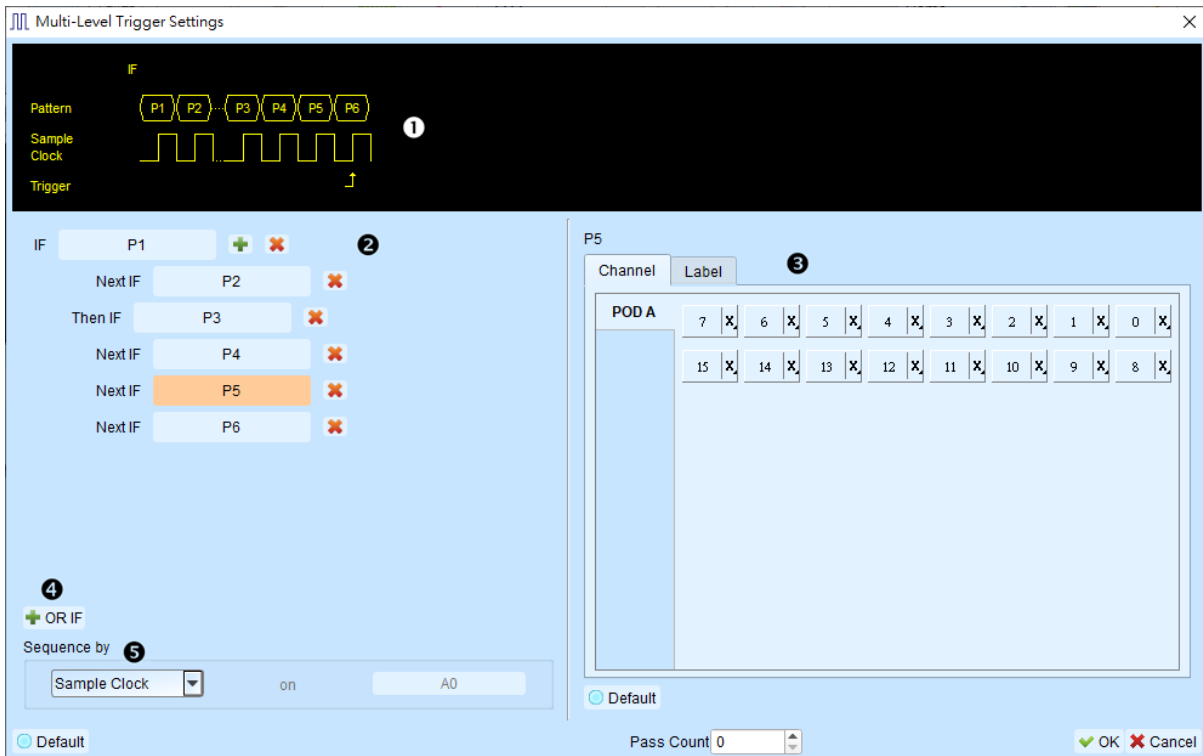

Difference between the continuous trigger and the non-continuous trigger lies in:

Continuous trigger: The signal captured by two adjacent sample clocks must meet the conditions to trigger.

Non-continuous trigger: It is triggered only when both the first condition and the second condition is met, no matter how many signals appear in between the first condition and the second condition. Therefore, such a trigger condition is not continuous at all.

A continuous trigger mode is usually set when Synchronous or State is used for measurement, because the use of synchronous clock is usually in a measurement state, and the signal is in a continuous state. Under the Asynchronous or Timing situation, it is common for the signal at the changing edge to meet the continuous triggering condition, while it is difficult for most of the signals to meet the conditions of continuous triggering, and therefore it is suitable to set non-continuous trigger as a condition for them.

3. The area to set the trigger condition for each class.

4. OR IF is the condition for establishing a parallel trigger. At this point, each set of trigger conditions are judging the conditions at the same time. It is triggered when any set of conditions is met.

5. Sequence by

The user can also set incidental conditions for triggering. In general, the data taken at the sampling point are used for trigger settings. If you want the specified channel at the changing edge to be triggered only, you should use the “Sequence by” setting. With such a function, the user does not have to set trigger conditions for each change at the edge, but just focus on the data to be set. For example, the signal data to be measured is valid only when the clock is at the rising edge. There are four data lines. In this case, you can set the Sequence by as Custom Rising, and then select the Clock pin as the valid condition for the data. Then, you can set the conditions for other data lines in accordance with Multi Level triggering conditions.

This function is not supported when the sampling frequency is above 2 GHz (inclusive).

- **Width Trigger**

The width trigger can set the trigger signal when the channel meets the trigger conditions and the length of the full pulse width.

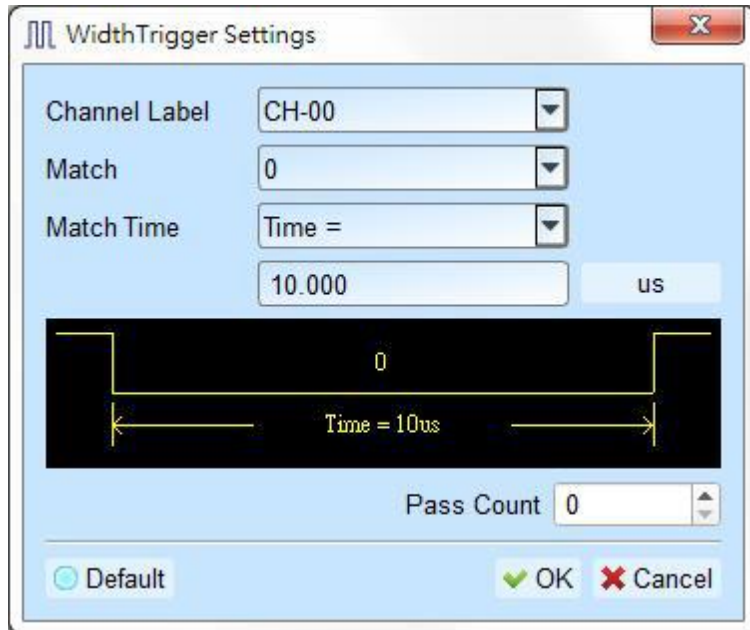

• **Timeout Trigger**

Timeout trigger can set the time width for trigger conditions. When the signal duration exceeds the set value, it will produce a trigger signal without waiting until a complete pulse is formed.

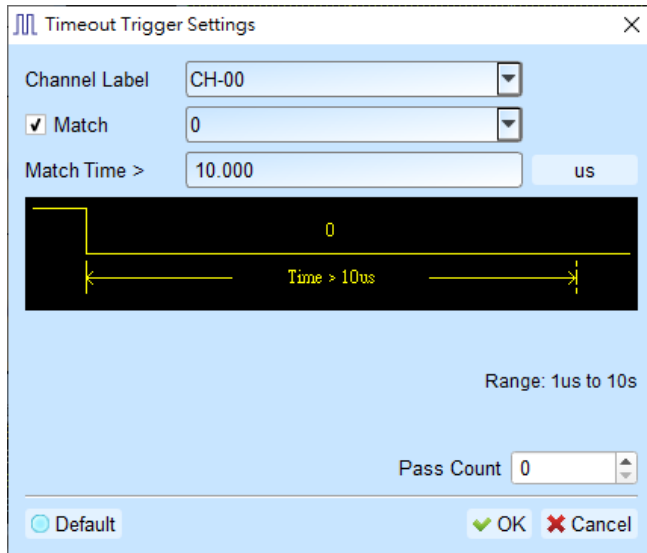

• **External Trigger**

The Trigger In input pulse signal of the device is taken as the trigger condition

• **Analog Trigger**

Use the Rise/Fall of MSO's built-in oscilloscope for trigger event.

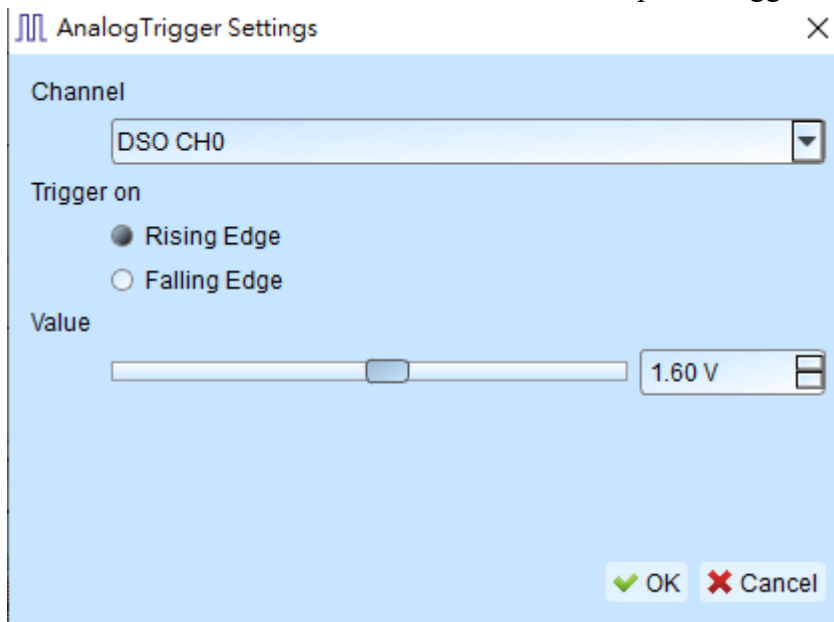

Channels, Threshold, Sample Rate, Device Memory Usage



Chapter 1 Digital Channel Settings:

- You can customize the channel you want to measure, and provide automatic threshold setting, or manual adjustment. 8 channels are a set of adjustable units, and there are two sets of thresholds that can be adjusted.
- Provide Extra Hysteresis function, turn on to reduce noise, turn off to increase sensitivity, replacing the past Schmitt function.
- The number of usable channels will vary depending on the trigger function setting or sampling rate.

Chapter 2 Analog Channel Settings:

- You can customize the channel you want to measure.
- Input Sensitivity provides two different revolutions
 - Voltage Range: $\pm 10V$, Minimum Scale: $5mV/Div$.

(2). Voltage Range: $\pm 20\text{V}$, Minimum Scale: 10mV/Div .

Chapter 3 Operating Mode Settings:

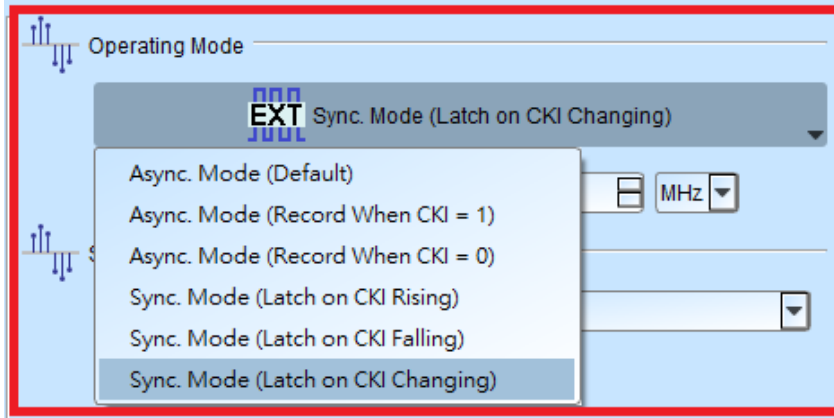

Asynchronous Mode:

Asynchronous mode, also known as timing analyzer, is based on the internal clock as a sampling frequency. It is recommended that the sampling frequency be set at about 10 times the signal to be measured, with the minimum not less than 5 times. Any rates lower than 5 times will cause distortion. Asynchronous sampling will cause sampling error from the actual capture to the signal, with the error time being the reciprocal of the sampling frequency.

The default mode is to capture the signal at the sampling frequency. If you want to increase the signal capture frequency, you can add a qualifier by selecting CK0 and setting a channel to be 0 or 1. For example, when Chip Select is 0 to allow to capture the signal, you can select the asynchronous mode (recorded when CK0 = 0) to add the qualifier. After the qualifier condition is selected, the device will automatically turn on the transpose mode to capture the signal.

Synchronous Mode:

Synchronous mode, also known as the state Analyzer, uses the external input clock as the sampling frequency. The channel marked with CK0 on the signal line is the external clock input channel. When the external clock stops, the signal capture will also stop, forming a synchronous operation between the two.

Chapter 4 Sample Rate:

MSO 2000series

Digital Available Channel	
Sample Rate	(Conventional/Transitional)
2 GHz (Max)	8 / 7
1 GHz	16 / 14
500 MHz	16 / 16
250 MHz	16 / 16
200 MHz below	16 / 16

Analog Available Channel	
Sample Rate	
200 MHz (Max)	2 (Ch0, Ch8)
100 MHz	4 (Ch0-1, Ch8-9)
50 MHz	8 (Ch0-3, Ch8-11)
25 MHz below	16

MSO 1000 series

Digital Available Channel		
	(Conventional/Transitional)	
Sample Rate	1008E	1116E
2 GHz (Max)	4 / 3	4 / 3
1 GHz	8 / 6	8 / 6
500 MHz	8 / 6	16 / 12
250 MHz	8 / 6	16 / 16
200 MHz below	8 / 6	16 / 16

Analog Available Channel	
Sample Rate	
200 MHz (Max)	2 (Ch0, Ch8)
100 MHz	4 (Ch0-1, Ch8-9)
50 MHz	8 (Ch0-3, Ch8-11)
25 MHz below	16

Chapter 5 Memory Settings:

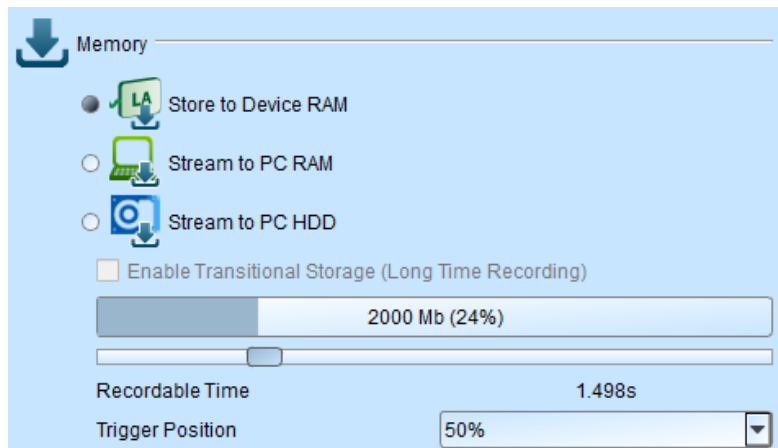

- a.** Storage Mode: Store to Device RAM, Stream to PC RAM, Stream to PC HDD

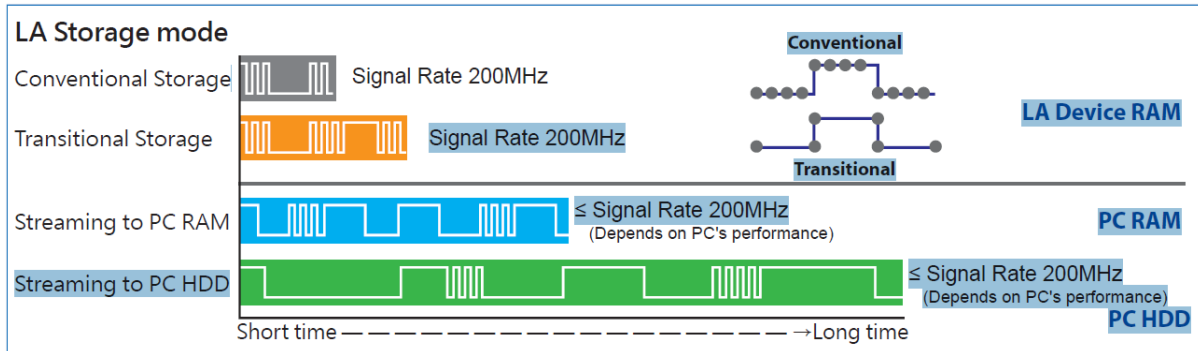

- b.** Transition Storage: Record the time intervals between edges. If the signal does not change frequently, the recording time can be greatly increased. **When MSO analog channels are enabled, it doesn't support transition storage mode.**
- c.** Record time: According to the current settings, the actual acquisition waveform time length is estimated, but when the transition storage is enabled, this function will be disabled without estimation.
- d.** Trigger Position : Set the position of the trigger point in the used memory in percentage. For example, set to 50%. Means that the device memory will retain up to 50% to store pre-trigger data.

Stack DSO(Oscilloscope)

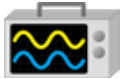

Using MSO and the Oscilloscope Stack functions, you need to install the special software provided by each oscilloscope brand. The software names are shown in the following table:

DSO brand	Software
Acute	Acute DSO software
Tektronix	Please download the TEKVISA CONNECTIVITY SOFTWARE from the Tektronix website.
Agilent Keysight	Please download the KEYSIGHT IO LIBRARIES SUITE from the Keysight website.
LeCroy	Please download the NI VISA and Drivers from the NI website.
HAMEG	Please download the NI VISA and Drivers from the NI website.
Rohde & Schwarz	Please download the NI VISA and Drivers from the NI website.

Oscilloscope supportive models:

DSO brand	Model	USB	TCP/IP
Acute	DS-1000 TravelScope	V	
Tektronix	TDS1000B/1000C/2000B/3000/3000B/ 3000C/5000B/7000 DPO2000/3000/4000/4000B/5000/7000 7000C/70000/70000B DSA70000/70000B MSO2000/3000/4000/4000B/5000 MDO3000/4000 TPS2000/2000B	V	V
Agilent	DSO1000A/5000A/DSO6000A/6000L 7000A/7000B/9000A MSO6000A/7000A/7000B/9000A DSO-X 4000A /MSO-X 4000A DSO-X 3000A /MSO-X 3000A DSO-X 2000A/MSO-X 2000A	V	V
Keysight	DSO-X 3000T MSO-X 3000T	V	V
LeCroy	WaveRunner / WaveSurfer / HDO4000 / HDO6000 / SDA 8 Zi-A / DDA 8 Zi-A		V
HAMEG	HMO3000/2000/1000	V	V
R & S	RTO1000/RTE1000		V

There are two methods for hardware wiring:

MSO is the Master, while the oscilloscope is the Slave.

Wiring direction is from MSO's Trig-Out the oscilloscope's Trig-In (see Figure 1)

Figure 1

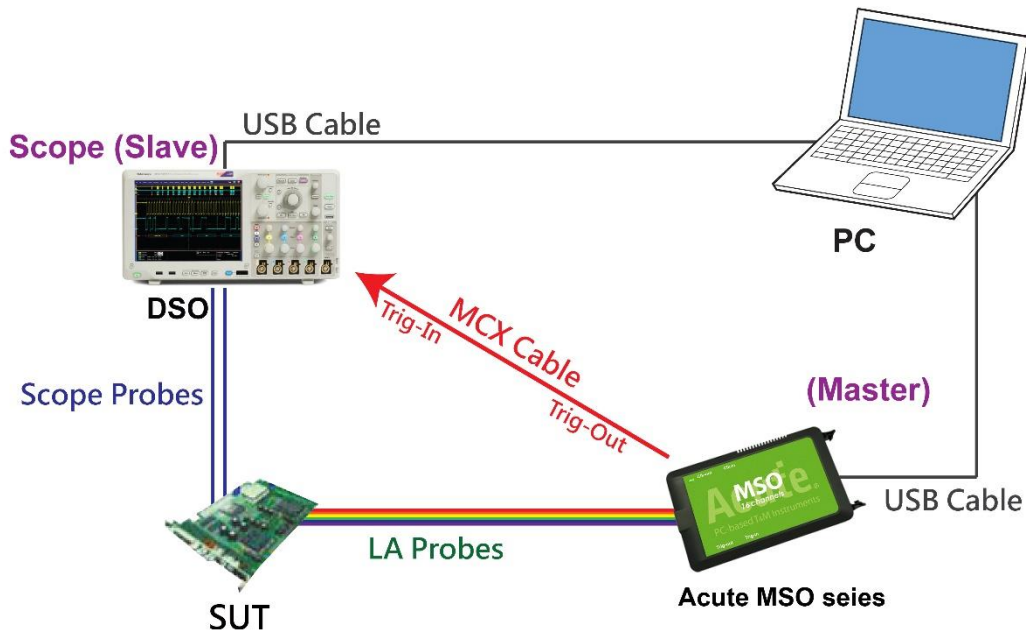

In Figure 1, the USB or Ethernet (TCP / IP) interface is connected to the computer, and then connect the BNC MCX cable to the MSO Trig Out and the trigger input interface (Ext Trig, Aux In or Trig In) of the oscilloscope. MDO4000 series is fixed in the analog channel CH4.

The oscilloscope is the Master, while the MSO is the Slave.

Wiring direction is from the oscilloscope's Trig-Out MSO's Trig-In (see Figure 2).

Figure 2

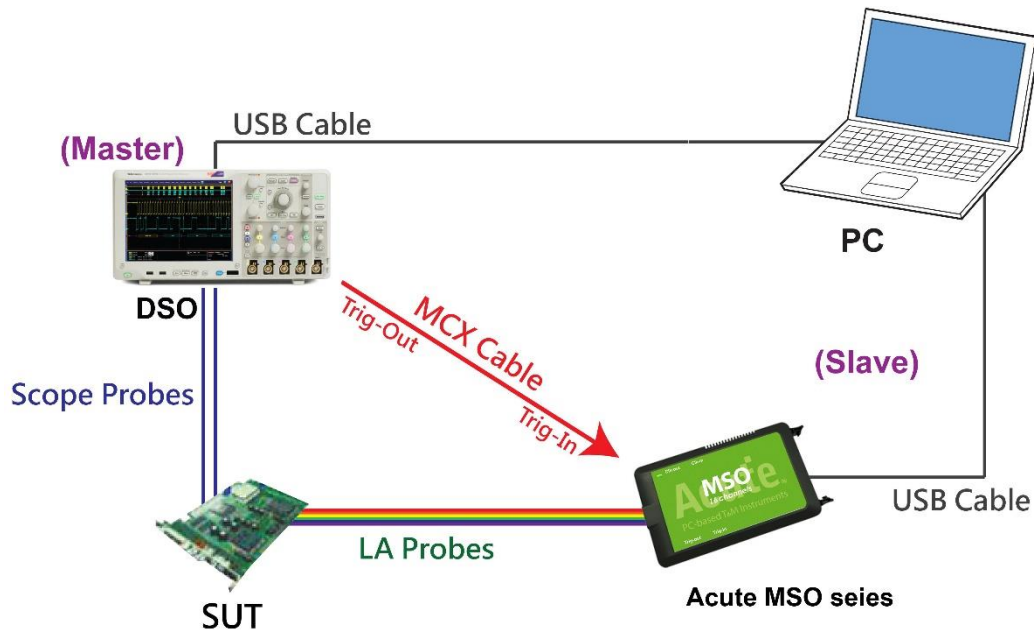

In Figure 2, the BNC-MCX cable is connected to the MSO Trig In and the trigger output interface (Trig Out) of the oscilloscope. After completing the above actions, press the "Stack Oscilloscope" button, as shown below:

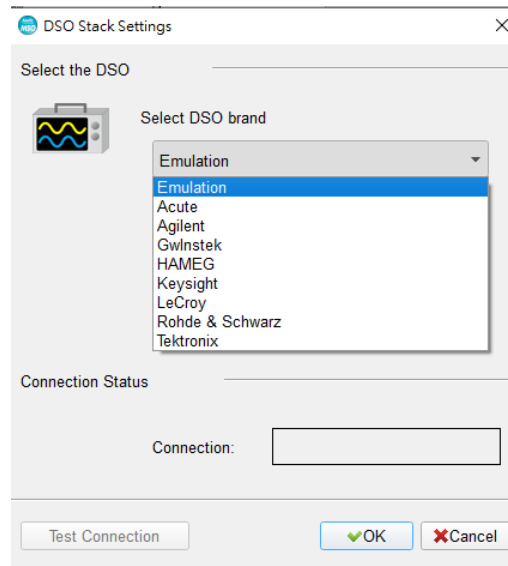
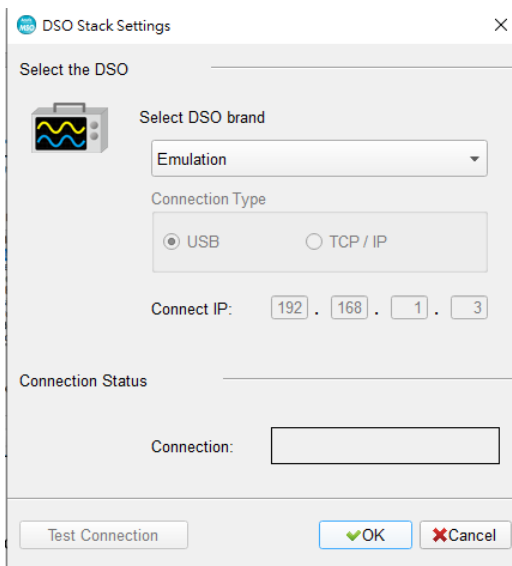

Select the DSO

Select the brand that needs to be stacked on the oscilloscope. When there is no DSO

hardware available for stacking, emulation is the mode used to read back the storage files of DSO stack.

Connection Type

It can be used to select USB, TCP / IP, according to the connection interface provided by the oscilloscope brands.

Connect IP

It can be used to select TCP / IP for the connection mode and enter IP address. When the Ethernet crossover cable is used, it is recommended that the IP settings of the two machines be 192.168.1.2 and 192.168.1.3 respectively. Gateway is the same, set to 192.168.1.1, and DHCP is set to OFF. If the IP setting does not take effect, please disable and then enable the network, or reboot to make the network settings effective.

Test Connection / Connection Status

It can be used to connect the oscilloscope / display the current stack oscilloscope model and automatically add the oscilloscope channel to the waveform window.

Screen of oscilloscope stack

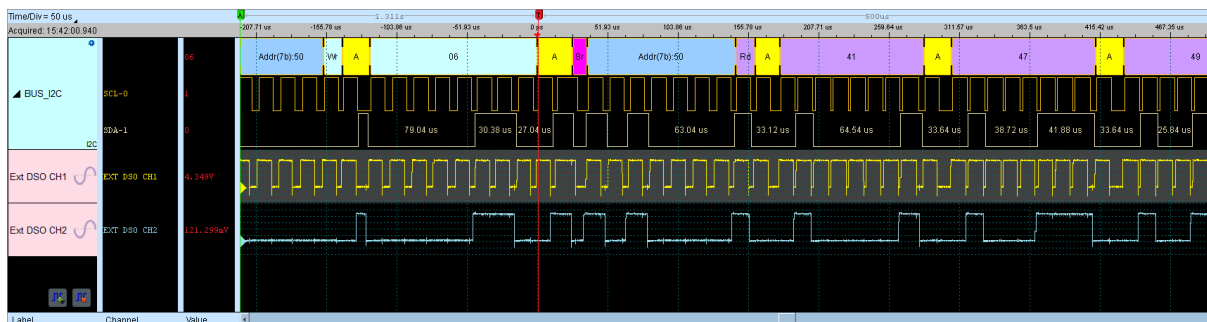

Oscilloscope is set as the master, while the MSO is set as the slave

If the stack is composed of the oscilloscope as the master and MSO as the slave, you must not only complete the above-mentioned basic settings but also set the external trigger signal. For the hardware wiring, please refer to Figure 2. Press "Trigger Condition" → "External

Trigger", as shown below

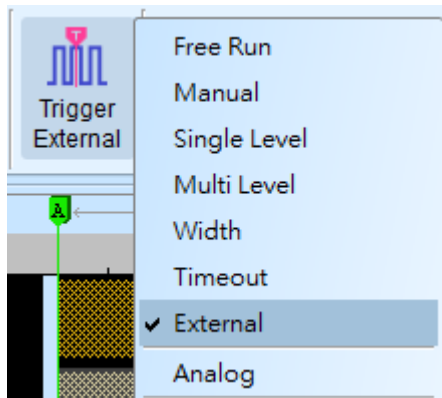

Stack Delay

When MSO is triggered successfully, the Trig-Out signal is transmitted through Cable to the DSO with a time delay, resulting in a deviation between the logic and the analog signal time displayed by the waveforms. Therefore, the stack delay time must be set to compensate the delay. In the waveform display screen, you can put the mouse on the top of the DSO waveforms, hold down the Shift key, and then use the mouse's left button to drag the DSO waveforms to the appropriate location to complete the stack delay correction.

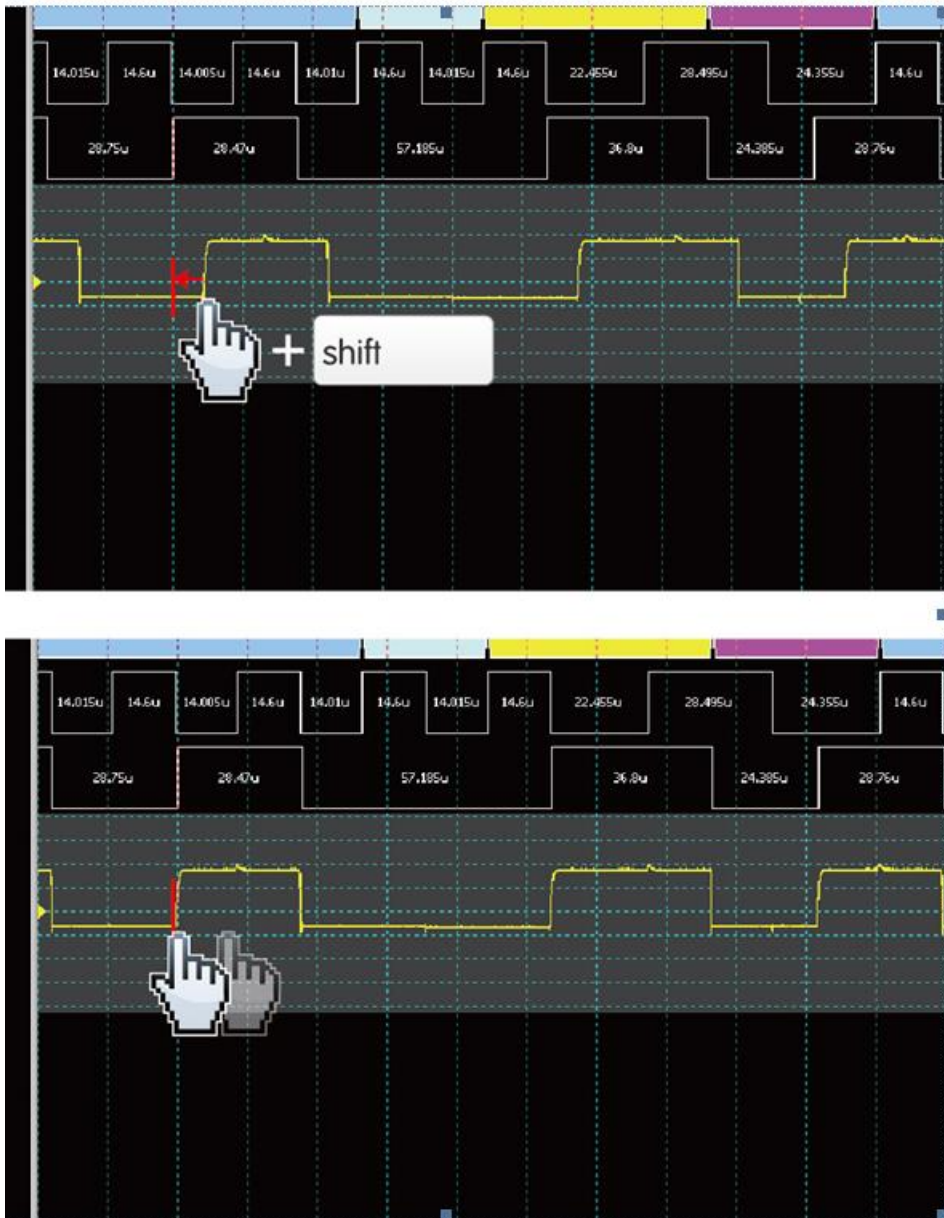

Stack Cable:

Standard MCX-MCX line for Acute DSO



Optional BNC-MCX line (50cm or 100cm) for standalone DSOs



Advanced Capture Settings

- Glitch filter settings



The hardware glitch filter function is used to filter out unwanted glitches and logical misjudgment caused by slow transitions. It can be regarded as a low pass filter to remind the user that the glitches may sometimes lead to poor quality of data transmission. You can use the Logic Analyzer and Oscilloscope Stack to determine the signal integrity and whether there are unexpected glitches.

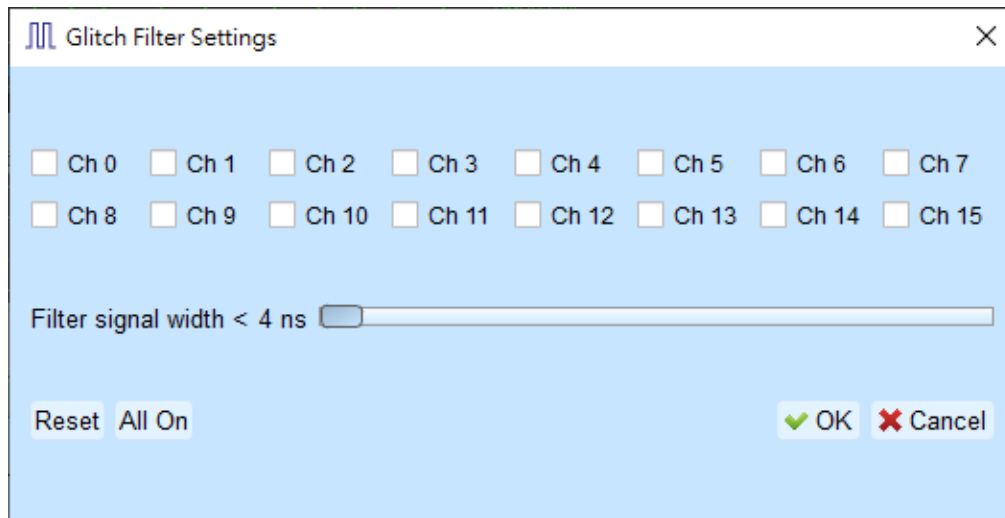

This filter function can be set to filter the signals of less than 5ns-35ns wide. After this filter function is enabled, it will filter before the hardware is triggered. Channels that use the glitch filter function are marked with a red dot on the channel label for identification

- **Software Glitch filter settings**

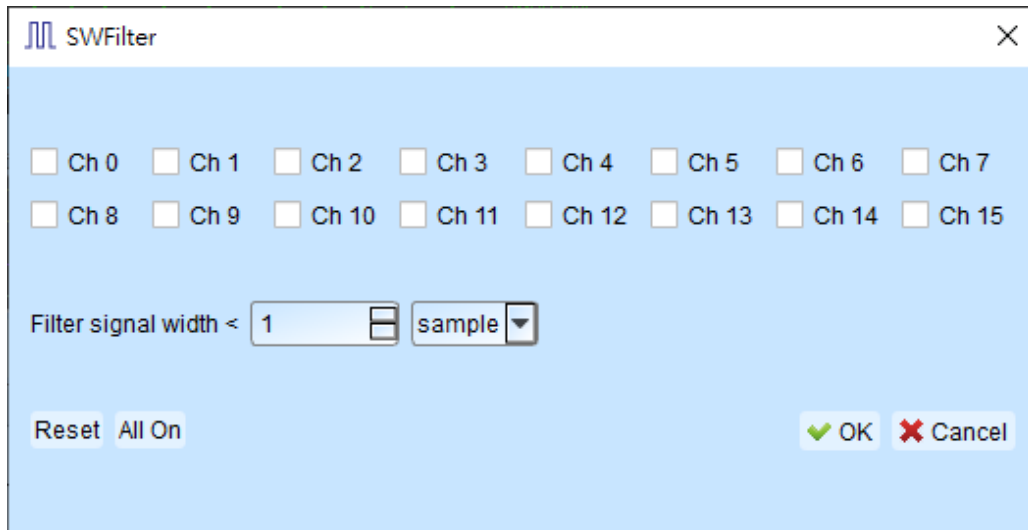

This filter function can be set to filter the signals with pulse width range from 1ps to 1ms. Applying this filter function will only change the display and decode contents, the trigger and recordable time will remain not effected Disabling this filter function will restore all waveform contents back to the original un filtered waveform.

• Timing Check

This function will import the .csv file of the timing check items; this file must be pre-input the parameters and measurement items. The main measurement types are the following two projects, and it can be judged whether it meets the design value.
(For sample files, Please contact us.)

1. HW Strap: Measuring the actual voltage at the sample points

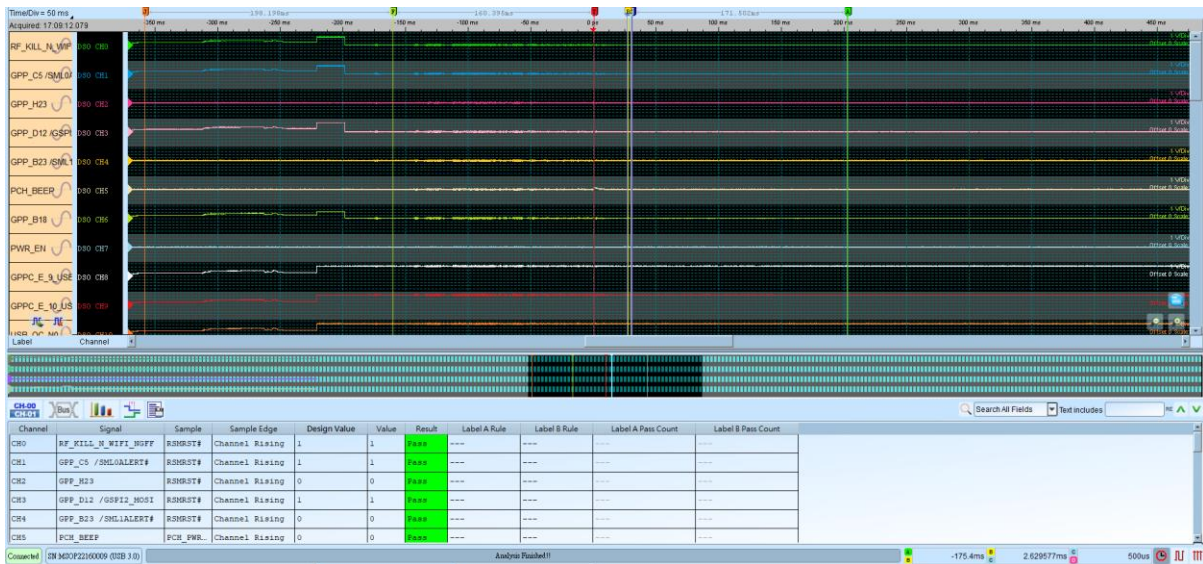

2. Timing sequence: Measuring power-on(off) sequence.

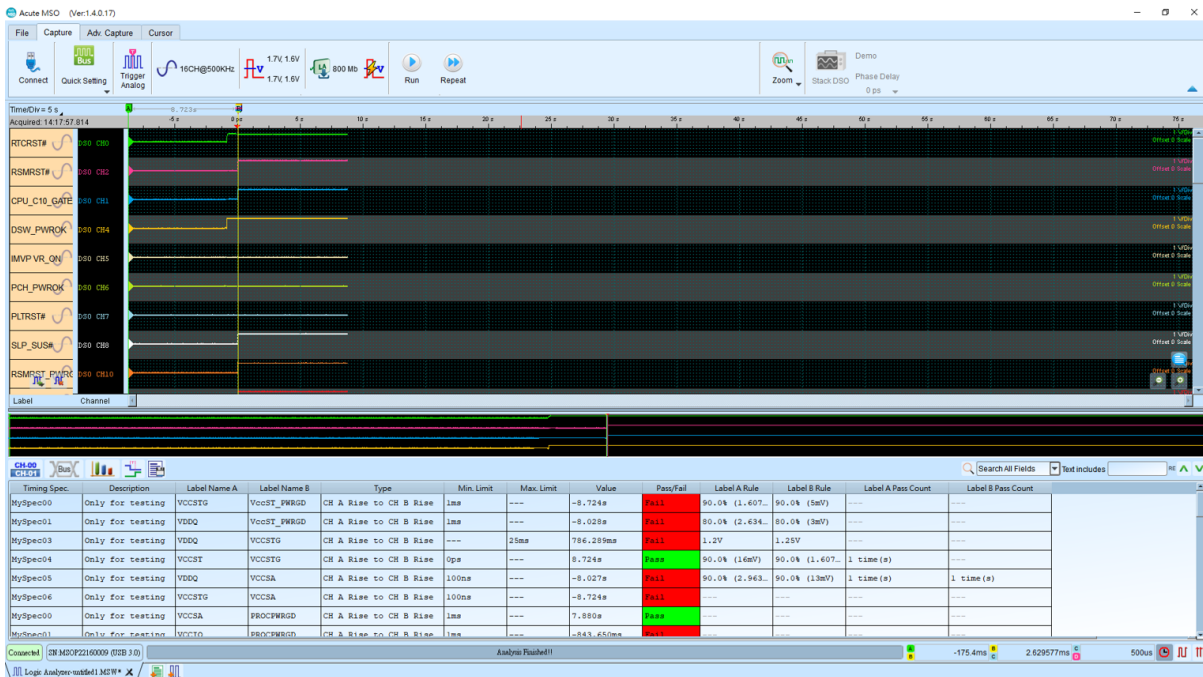

1. Generating a power sequence html format report:

The power sequence report provides with waveform screenshots and testing results, and it is available to edit the report title and user-defined information.

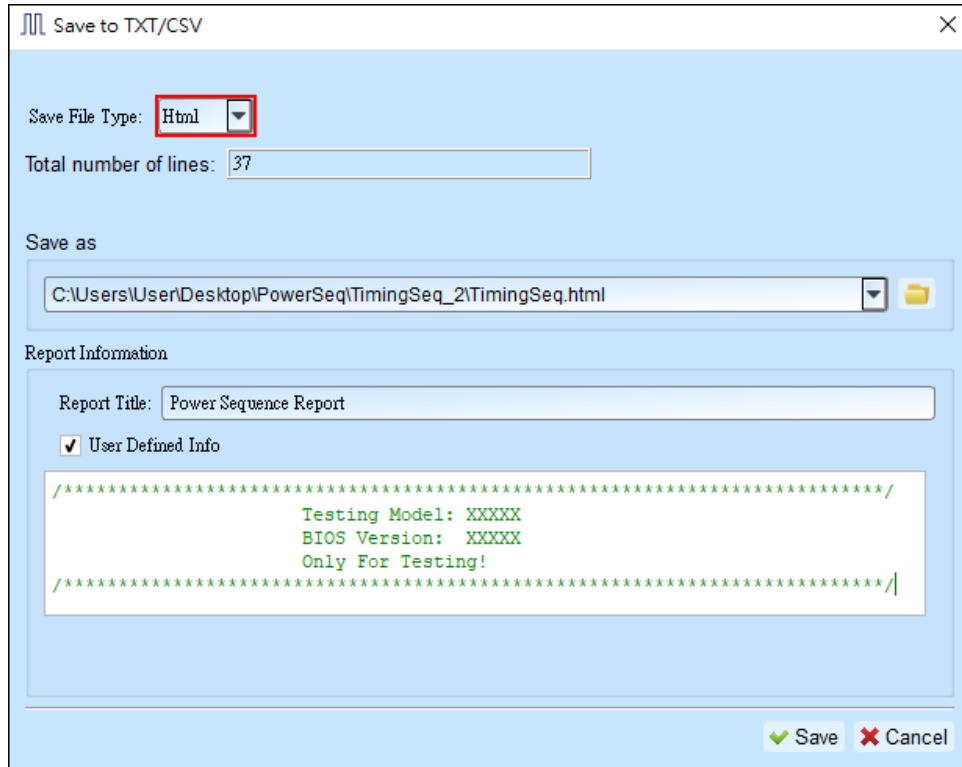

Power Sequence Report

Test Instrument Model	MSO2216B+
Test Instruments Serial Number	MSOP22160006.MSOP22160009
Test Date	Aug-10-2020 17:26:11
S/W Version	1.4.40

```

Testing Model: XXXXX
BIOS Version: XXXXX
Only For Testing!
    
```

Overview Results: 17 of 37 Test Pass

Timing Spec.	Description	Min. Limit	Max. Limit	Value	Pass/Fail
MySpec00	Only for testing	1ms	---	175.263ms	Pass
MySpec01	Only for testing	1ms	---	186.113ms	Pass
MySpec03	Only for testing	---	25ms	101.091ms	Fail
MySpec04	Only for testing	0ps	---	-181.487ms	Fail
MySpec05	Only for testing	100ns	---	219.998ms	Pass

MySpec01 - Test Result: **PASS** ✓

Description: Only for testing

Label Name A	Label Name B	Type	Min. Limit	Max. Limit	Value	Label A Rule	Label B Rule	Label A Pass Count	Label B Pass Count
VDDQ	VccST_PWRGD	通道A上升到通道B上升	1ms	---	186.113ms	80.0% (2.676V)	80.0% (2.009V)	---	---

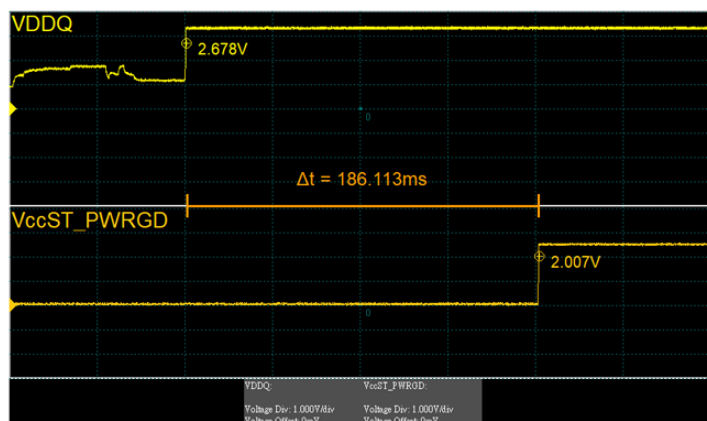

Cursor

This function includes the cursor setting and the waveform search function matching the cursor.

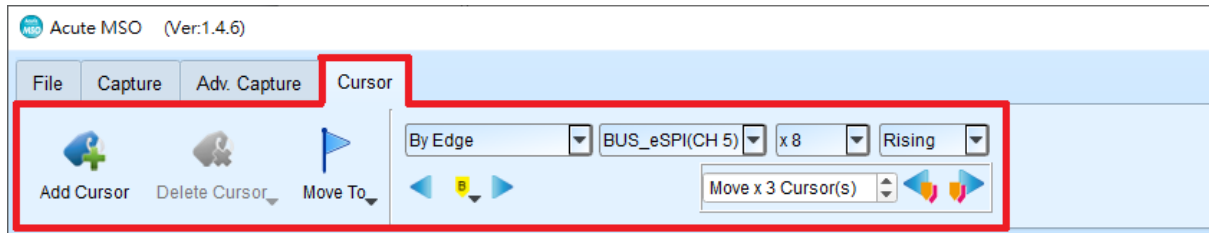

Move To: Move the focused timestamp position in the waveform area according to the selection.

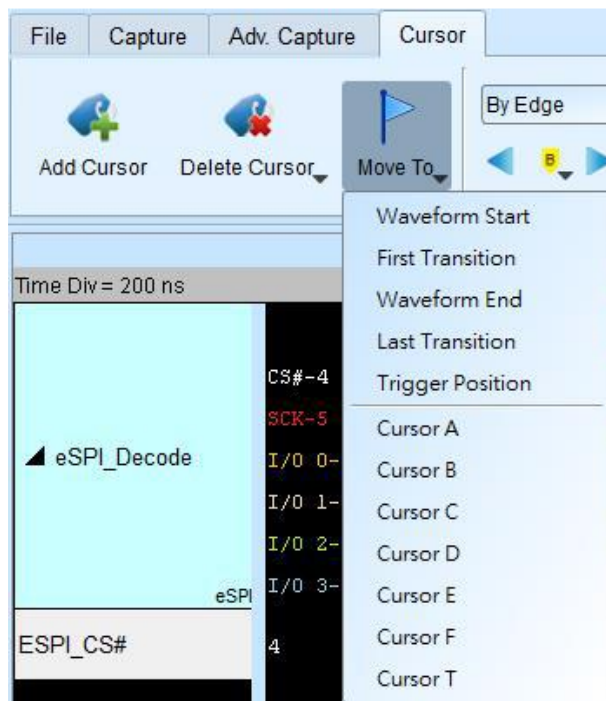

Waveform Start: Move to the beginning of waveform

First Transition: Move to first waveform transition

First Transition on Selected Label: Move to first waveform transition of selected label

Waveform End: Move to the end of waveform

Last Transition: Move to last waveform transition

Last Transition on Selected Label: Move to the last waveform transition of selected label

Trigger Position: Move to the trigger position

Cursor A-Z: Move to the Cursor position

Waveform search is divided into four modes:

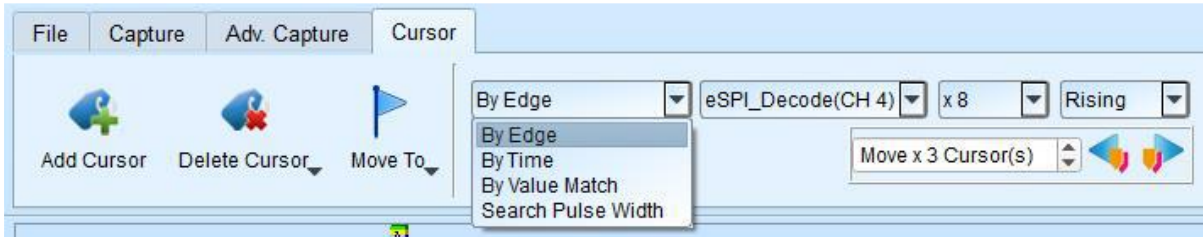

1. **By Edge:** Move the specified cursor position according to the number of Rising/Falling/Either edges (x1 ~ x4096) of the specified channel.

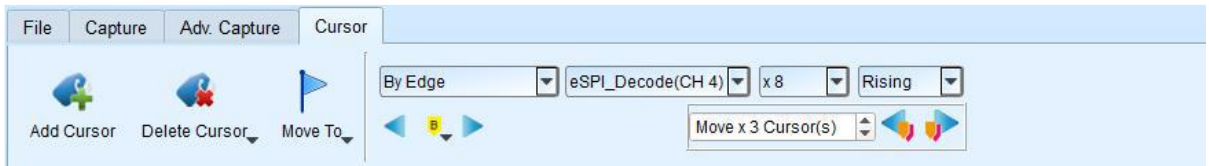

2. **By Time:** Move the specified cursor position forward or backward to specify the amount of time.

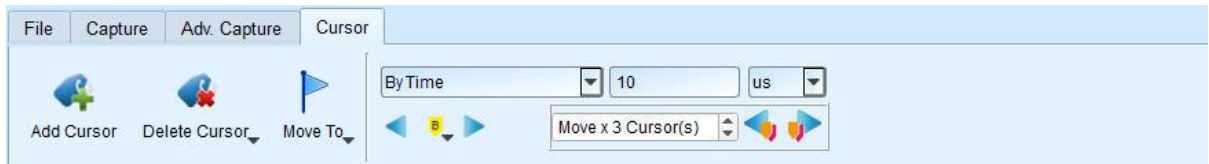

3. **By Value Match:** In search of displayed value content of the specified channel, if the specified channel is the bus Protocol, the text comparison will be used for the search; if the specified channel is the bus or channel, the numerical comparison will be used for the search.

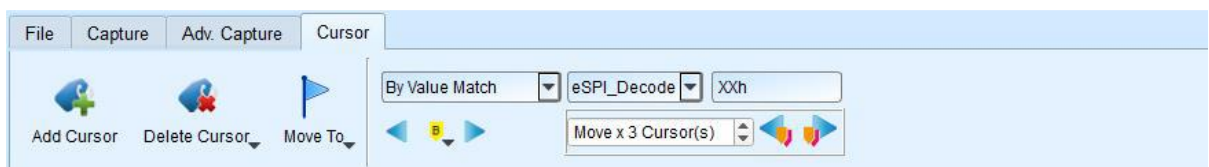

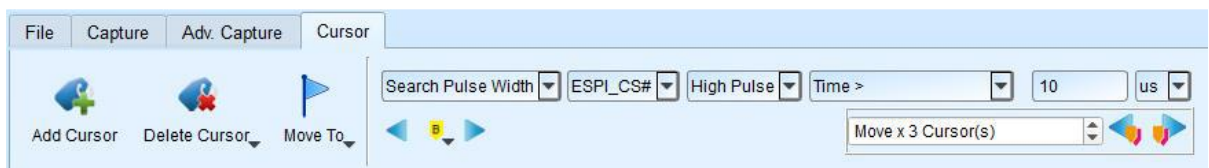

4. **Search Pulse Width:** The waveform pulse widths meeting the conditions can be searched on the specified channels. The single-cursor movement function on the left side or the multiple-cursor movement function on the right side can be used on any operation meeting or exceeding the conditions.
All of the above operations can be used to move a single cursor on the left or multiple cursors on the right.



The starting point of the search is set to the current position of the selected cursor.

Cursor usage:

The cursor system has two special purpose cursors: the triggering cursor T and the search specific cursor B, respectively. To add a new cursor, you can use the left mouse button to click the “Add Cursor Button” () on the top or press the Shift+ letter key. To delete a cursor, you can click the “Delete Cursor Button” () on the top.

Cursor movement method:

1. Using the left mouse button to drag the cursor sign or cursor line on the top of the waveform window, you can achieve the purpose of moving the cursor.
2. Use the keyboard A-Z to quickly navigate to the mouse cursor location.
3. Use the keyboard Shift + A-Z to move the cursor to the place where the mouse cursor is.
If the cursor does not exist, you can add the cursor to the mouse cursor without dragging the cursor.

The value on the frequency / time display bar at the bottom right of the screen will change as the cursor moves.



From left to right are the interval time, frequency calculation, the number of sampling statistics, respectively.

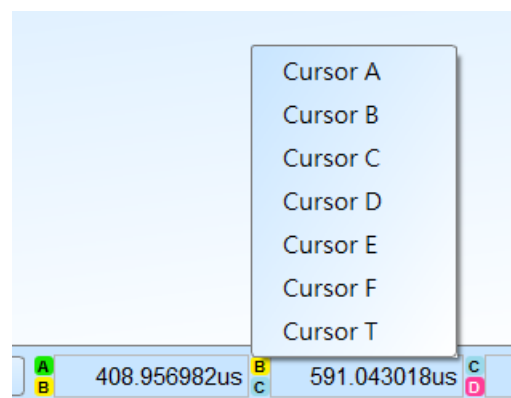



Clicking the cursor name, you can switch the cursor.

Waveform And Report

Waveform

1. Use the left mouse button to drag the waveform in the wave form display area.
2. You can use the mouse wheel or click the zoom in button on the screen to zoom the

waveforms in or out .

3. To add text/graphic annotation , you can add text or graphic annotation data in the waveform area.

4. Quick calculation function

If you press the right button to drag in the waveform display area, you can circle the range to be observed, and show the number of signal transitions in the observation interval, the length of time and the average frequency information. This function can also be used in the waveform display area under the protocol Analyzer mode.

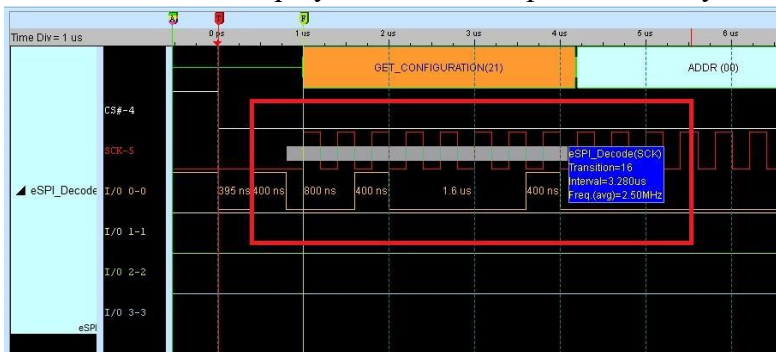

5. Add/Delete the waveform label.

- Add labels

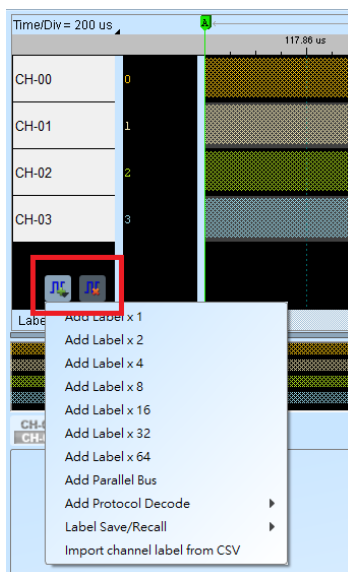

● Add parallel bus

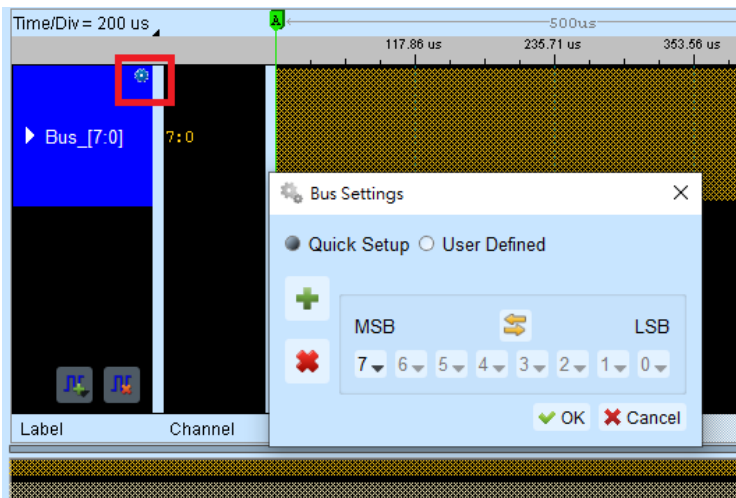

● Add protocol decode

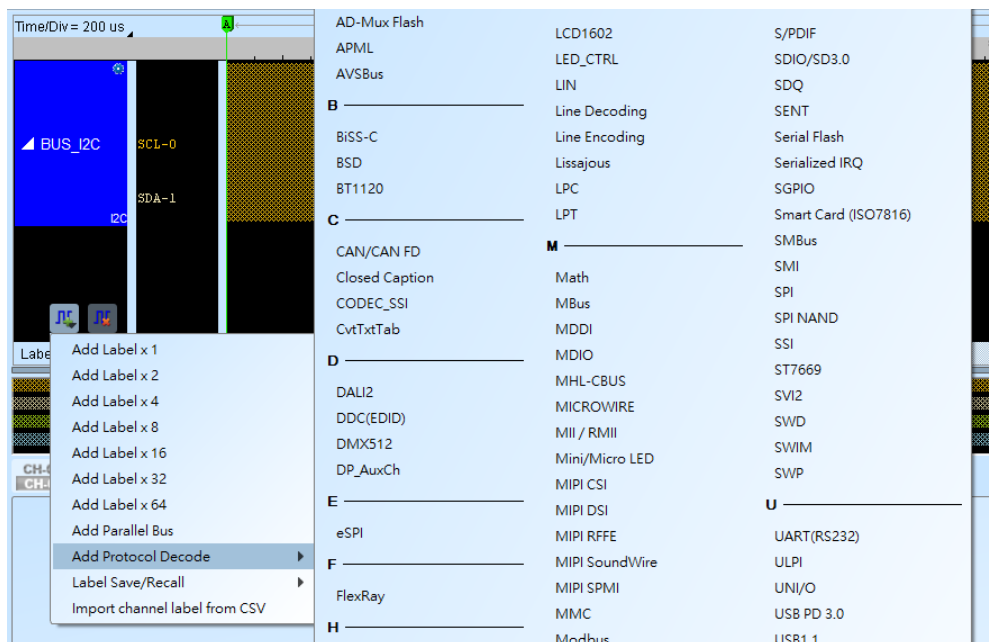

- Label Save/Recall: Save the current channel settings or load the saved channel label.
- Import channel label from CSV file. The file format like the following,

	A	B	
1	name1	1	
2	name2	2	
3	name3	3	
4	name4	4	
5			

Notice: The feature can only import channel name and number. It can't import parallel bus or protocol decode.

Report Area

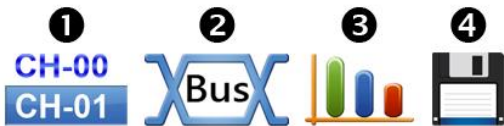

1. Display the channel status.
2. Display the results of the bus decode, or create customize report from multiple decodes.
3. Waveform data statistics

When setting, select the channel and determine the type of statistics. If you only need to count the specific range, you can use the cursor to select the specified range. By default, the range is the entire waveform area. To apply the same measurement values to other channels, you need only click and drag the items to be copied, and multiple sets of the same measurements will be added to the other channels. To add a variety of measurement values on the same channel, you need only to click and drag on the channel name, and a number of different types of measurements will be added.

Digital Measurement:

Type	Channels
Period	1
Frequency	1
Edge Count	1
Cycle Count	1
Positive Cycle Count	1
Negative Cycle Count	1
Positive Pulse count	1
Negative Pulse count	1
Positive Pulse Width	1
Negative Pulse Count	1
Channel-to-Channel Rising Delay	2
Channel-to-Channel Falling Delay	2
Channel Rising to Channel Falling Delay	2
Channel Falling to Channel Rising Delay	2
Phase Delay	2

Analog Measurement:

Type	Channels
Frequency	1
Period	1
V Max.	1
V Min.	1
V High	1
V Low	1
V Peak to Peak	1
V Amplitude	1
V RMS.	1
V Mean	1
V Mid	1
High Duty	1
Low Duty	1
High Period	1
Low Period	1
Rise Time	1
Fall Time	1
V Pos. Overshoot	1
V Neg. Overshoot	1
V Rising Pre-shoot	1
V Falling Pre-shoot	1
Ch to Ch Rising Delay	2
Ch to Ch Falling Delay	2
Ch Rising to Ch Falling Delay	2
Ch Falling to Ch Rising Delay	2
Phase Delay	2
Rising Edge Count	1
Falling Edge Count	1
Edge Count	1

4. Report area storage

Report contents can be saved as text files.

Bus Decode Settings

Please see the bus trigger and Analyzer manual.

Customized Report Settings

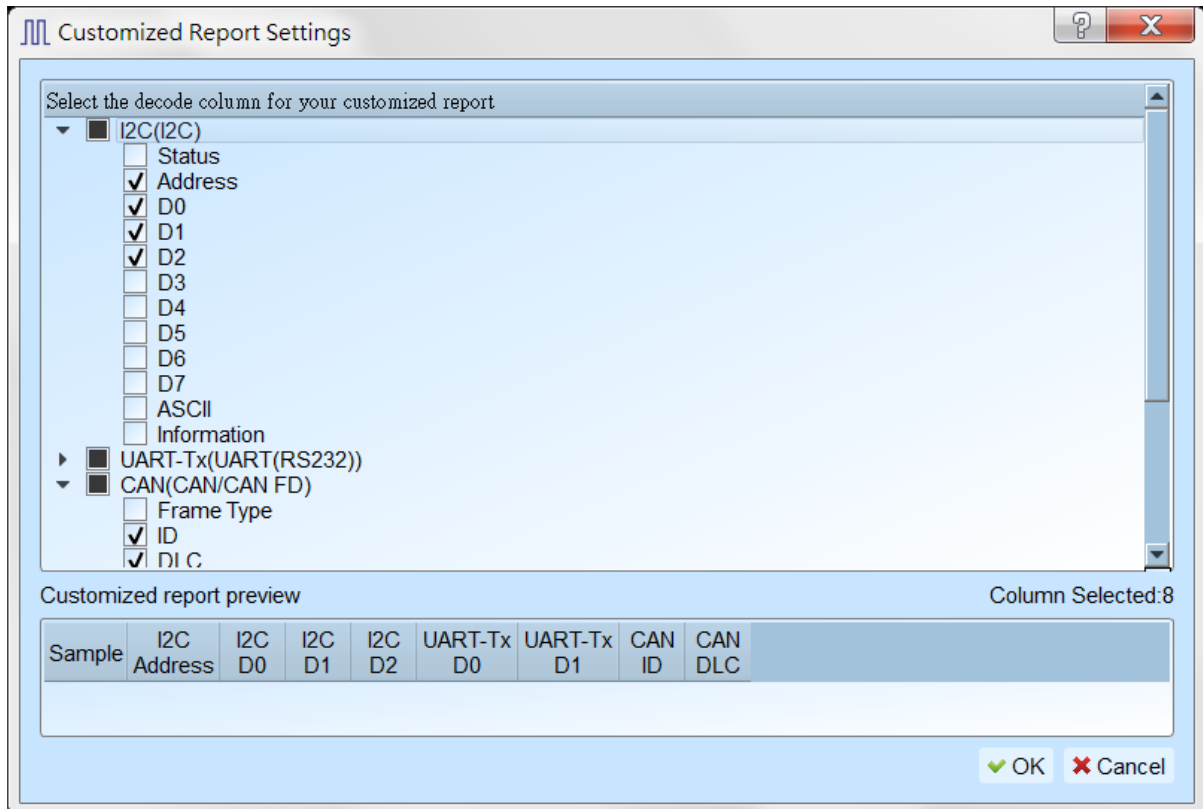
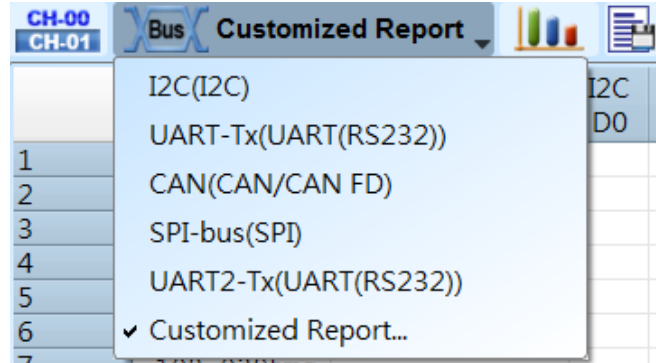

All Bus Decoders enabled in waveform area will be listed in the setting window, you may select interested columns from each Reports, the preview window will show how many columns you have selected and combine them to create your customized report.

Note: The Bus Decoders must be setup correctly in order to fetch the correct column names for the customized report.

Chapter 3 Technical Support

Contact information

Acute website: <https://www.acute.com.tw>

E-Mail: service@acute.com.tw

Tel: +886-2-29993275 傳真: +886-2-29993276

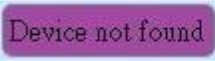
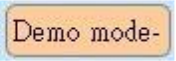
If   shows up in the Demo mode during the execution of MSO software, please try the following steps to solve the issue:

- (1) Install the latest version of the MSO software, please go to the official website of [Acute Technology Inc. – Download - Software](#), and then select the [MSO](#) to download and install.
- (2) Please use the original USB3.0 Cable in the kit.
- (3) Go to the device manager and check the driver status

Please connect the device USB cable to the computer and then go to the system device manager to check whether the Acute USB Bootloader or Acute USB3.0 Product shows up. Please go to the Acute Website-Download -Software, download the USB3.0 driver and follow the troubleshoot manual in the package to reinstall the driver.

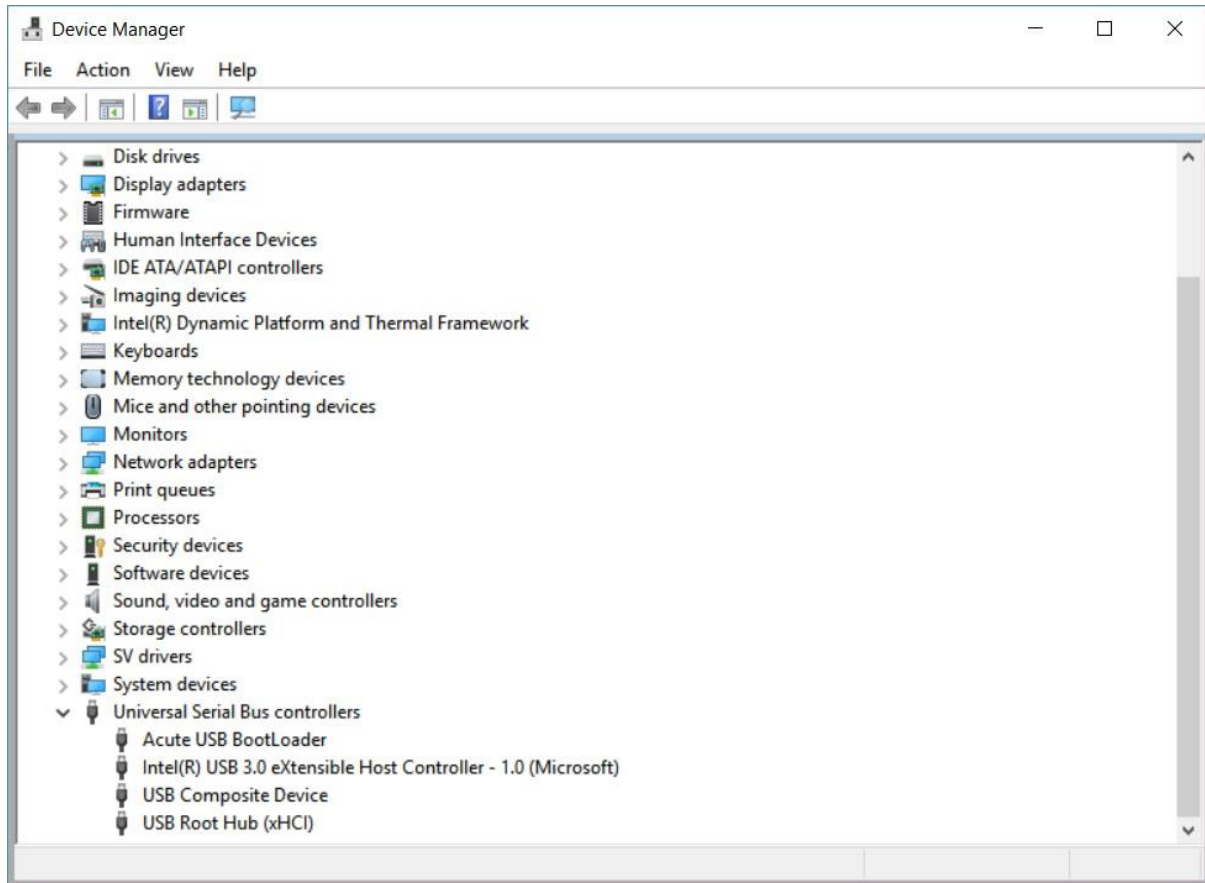

- (4) Remove all probes and re-plug the USB3.0 Cable or restart the computer to check whether the driver appears.
- (5) After the above steps are taken but the problem is still there, please contact us.