



- Hi-Speed data, SuperSpeed data and power lines can be separately enabled for each downstream port
- Set programmable current limits for each downstream port (up to 4A)
- Dedicated Control Port for software control; independent of the selected upstream port
- Automatic or programmed selection for either of 2 upstream-facing host port connections
- All ports support USB link speeds up to 5Gbps
- Detect established link speed on each port: SuperSpeed (5Gbps) or Hi-Speed (480Mbps)
- Selectively enable USB charging mode behaviors: SDP (Standard Downstream Port) or CDP (Charging Downstream Port) modes¹
- Deliver up to 4.0A per port (in CDP mode)
- Set enumeration delay for discovery of attached downstream devices
- Backward compatible with USB 2.x and USB 1.x devices
- Boost USB2 upstream and downstream signal levels
- DIN-rail mountable
- Alternate Euro-style terminal block power input connector
- Certified to $\pm 15\text{kV}$ ESD strikes (IEC61000-4-2 level 4)
- Overvoltage and reverse current protected V_{bus} outputs

Overview

The USBHub3+ is an 8-port software-programmable USB 3.2 Gen 1 (5 Gbps) hub designed for demanding industrial environments where advanced control and monitoring of USB ports is required. Ideal for testing or development environments where standard “always-on” behavior of a consumer-grade USB hub is not desirable.

Software control of the USBHub3+ is established and maintained over one of two available upstream-facing host ports or via a dedicated Control Port connection.

The USBHub3+ can be used to enable/disable individual USB ports, measure current or voltage on downstream USB ports, set programmable current limits, set USB charging protocol behavior and otherwise automate USB port behaviors in development and testing.

Typical applications include:

- USB device manufacturing
- USB device validation and development
- Plug/unplug cycle testing
- Functional testing
- Battery charging
- USB device resets
- USB power monitoring
- Controlling USB device enumeration sequence

Features

- Supports USB hosts and devices up to USB 5Gbps
- Individually enable/disable any of 8 downstream ports
- Measure voltage and current on each downstream port

Description

The USBHub3+ gives engineers advanced flexibility and configurability over USB ports in testing and development applications.

Each downstream USB channel implements separately and independently switched data lines and current-limited power lines. USB power, data and SS data can be independently disconnected for advanced USB testing applications. Pin interfaces are protected against reverse polarity and over-voltage. Connections are designed to operate from 0°C to 50°C ambient with no external cooling or fans.

Each USBHub3+ is uniquely addressable and controllable from a host PC via the selected USB host input or through a dedicated Control Port. Acroname's BrainStem™ link is then established over the USB input and allows a connection to the on-board controller in the USBHub3+. USBHub3+ can be controlled via a host running BrainStem APIs or alternately, it can operate independently by running locally embedded, user-defined programs based on Acroname's BrainStem Reflex language.

¹ See http://www.usb.org/developers/docs/devclass_docs/ under the category Battery Charging for full details.

Absolute Maximum Ratings²

Stresses beyond those listed under ABSOLUTE MAXIMUM RATINGS can cause permanent damage to the device. These are stress ratings only and functional operation of the device at these or any other conditions beyond those indicated under RECOMMENDED OPERATING CONDITIONS is not implied. Exposure to absolute-maximum rated conditions for extended periods affects device reliability and may permanently damage the device.

Parameter	Minimum	Maximum	Units
Input Voltage, V_{supply}	0.0	30.0	V
Input Power, P_{supply}		85	W
V_{bus} Output Power		65	W
Input Current, Barrel Connector only		5.0	A
Voltage on any upstream V_{bus} line	0.0	5.1	V
Voltage on any downstream V_{bus} line	0.0	13.2	V
Voltage on any USB D+/D-, upstream and downstream	-0.3	5.1	V
Altitude	-	2000	M
Overvoltage	-	Overvoltage Category II	-

Table 1: Absolute Maximum Ratings

Handling Ratings

Parameter	Conditions/Notes	Minimum	Typical	Maximum	Units
Ambient Operating Temperature, T_A	Non-Condensing, in support of IEC 60950	0.0	25.0	25.0 ^{3,4}	°C
Relative Humidity Range	Non-Condensing	5	-	95	%RH
Storage Temperature, T_{STG}		-10.0	-	85.0	°C
Electrostatic Discharge, V_{ESD}	Meets IEC 61000-4-2, level 4, air-discharge	-15	-	+15	kV
	Meets IEC 61000-4-2, level 4, contact-discharge	-8	-	+8	kV

Table 2: Handling Ratings

Recommended Operating Ratings

Specifications are valid at 25°C unless otherwise noted. Intended for indoor use only.

Parameter	Conditions/Notes	Minimum	Typical	Maximum	Units
Input Voltage, V_{supply}		9.0	12.0	24.0	V
Input Power, P_{supply} ⁵				70	W
USB V_{bus} on downstream ports	Hub powered; Port power enabled	0.0	5.1	13.2	V

² If the equipment is used in a manner not specified by the manufacturer, the protection provided by the equipment may be impaired.

³ DC power input supply, YHY/YHY-12005000 (<https://acroname.com/store/r469-acdc-ps-3>) that is included with USBHub3+ is limited in ambient operating temperature.

⁴ DC power input supply must meet operating temperature as specified by manufacturer specifications to match specified ambient maximum operating temperature specifications (T_A).

⁵ DC power input supplies are required to be limited in power output to specified value and thermally limited for safety. The supply must be approved (IEC/UL/EN 62368 or IEC/UL/EN 60950) with output power limiting.

	Hub powered; Port power disabled	0.0	0.0	13.2	V
Relative Humidity Range	Non-Condensing	5	-	80	%RH

Table 3: Recommended Operating Ratings

Block Diagram

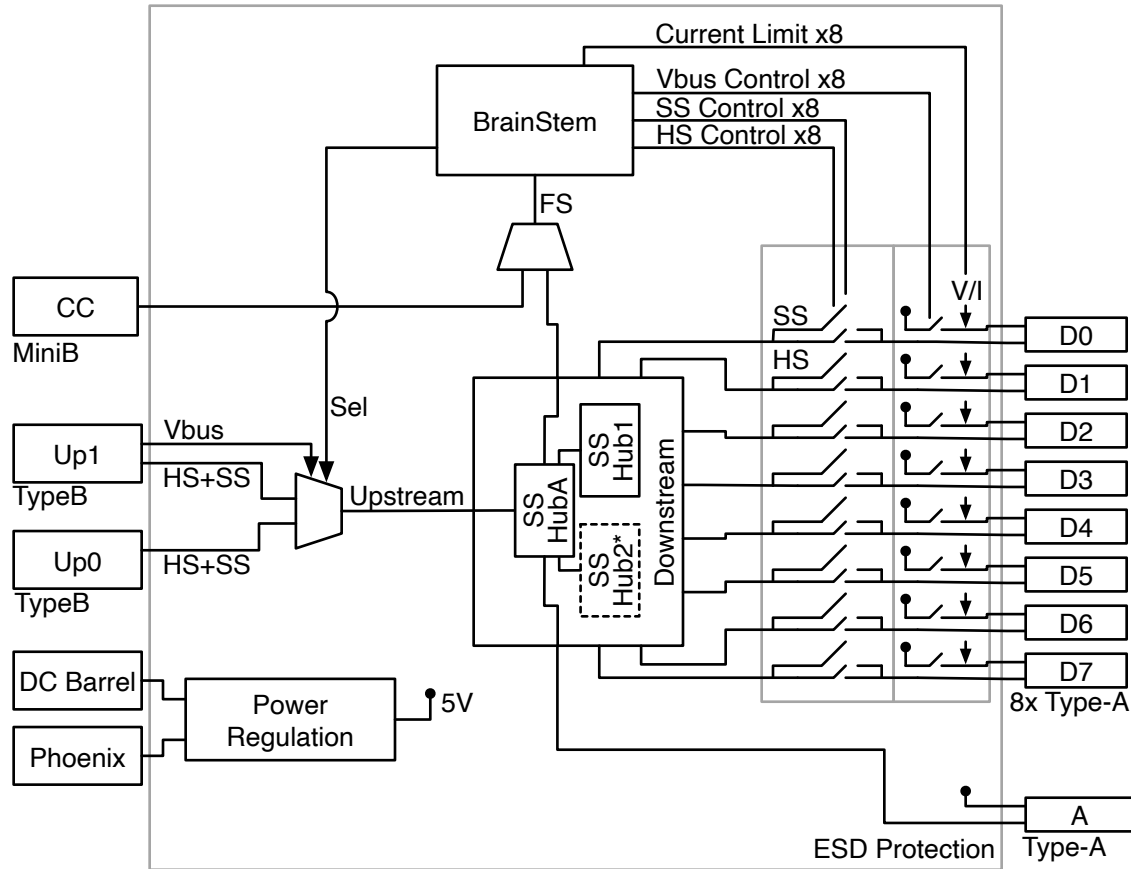

*The BrainStem controller and DownA are always connected to the root hub. There may be 1 or 2 leaf hubs connected to 1 the root hub.

Figure 1: USBHub3+ Block Diagram

Typical Performance Characteristics

Specifications are valid at 25°C unless otherwise noted. Indoor application use only.

Parameter	Conditions/Notes	Min	Typ.	Max	Units
Input Power, W_{supply} , no downstream devices attached		-	2.2	-	W
V_{supply} Under Voltage Lockout (UVLO)		7.5	8.0	8.2	V
V_{supply} Over Voltage Lockout (OVLO)		26.0	26.8	27.8	V
Wide Input Range System Efficiency	At 12.0V input, nominal 8A load ⁶	84	-	92	%
USB Downstream Output Voltage, V_{bus}	No load on downstream USB ports	4.947	5.10	5.25	V
V_{bus} Measurement Resolution		-	8.0	-	mV
V_{bus} Measurement Accuracy		-2.0	-	2.0	%
V_{bus} Short-circuit Trip Current, I_{limit}		4.8	5.0	5.4	A
V_{bus} Short-circuit Trip Time, t_{limit}		-	0.7	-	μS
V_{bus} Short-circuit Average Current, I_{short}	After trip	0.3	0.5	2.0	A
V_{bus} Current Measurement Resolution		-	1.0	-	mA
V_{bus} Current Measurement Accuracy	V_{bus} current < 4.00A	-1.0	-	1.0	%
V_{bus} Current Measurement Range		0	-	4095	mA
V_{bus} Current Limit Trip Point Range	Software programmable	0	-	4095	mA
V_{bus} Current Limit Trip Point Resolution		-	1.0	-	mA
V_{bus} Overcurrent Trip Time t_{trip}	Time from overcurrent load to port power switch disconnect.	.20	1.0	3.4	ms
V_{bus} Overvoltage Threshold V_{ov_thresh}		-	5.4	-	V
V_{bus} Overvoltage Trip Time t_{ov_trip}	Trip by overvoltage or reverse current	-	10	-	ms
V_{bus} Overvoltage Trip Recovery Time t_{ov_en}	Auto-enable V_{bus} after trip	-	70	-	ms
USB SuperSpeed Data Rate	May depend on host or devices	-	-	5	Gbps
USB Hi-Speed Data Rate	May depend on host or devices	-	-	480	Mbps
V_{bus} Current Supply (SDP mode)	USB2 data lines disabled or no USB host present, device limited	-	100	-	mA
V_{bus} Current Supply (SDP mode)	USB2 data lines enabled and USB host present, device limited	-	500	-	mA
V_{bus} Current Supply (CDP mode)	USB2 data lines enabled, USB host present, device limited	-	1500	-	mA
V_{bus} Current Supply (DCP mode)	USB2 data lines enabled, no USB host present, device limited	-	5000	-	mA
Input current CH0 upstream port, I_{Vbus}	No V_{supply} present, USB2 type-B cable	-	180	-	mA
Input current CH0 upstream port, I_{Vbus}	No V_{supply} present, USB3 type-B cable	-	425	-	mA
Input current measurement resolution, I_{supply}	Through barrel jack or Euro-style connector only	-	4.0	-	mA
I_{supply} accuracy		-2.0	-	2.0	%
Input voltage measurement resolution, V_{supply}	Through barrel jack or Euro-style connector only	-	8.0	-	mV
V_{supply} measurement accuracy		-2.0	-	2.0	%

Table 4: Typical Performance Characteristics

⁶ Representative 8A load based on 8 USB downstream devices running in CDP mode consuming approximately 1.0A each.

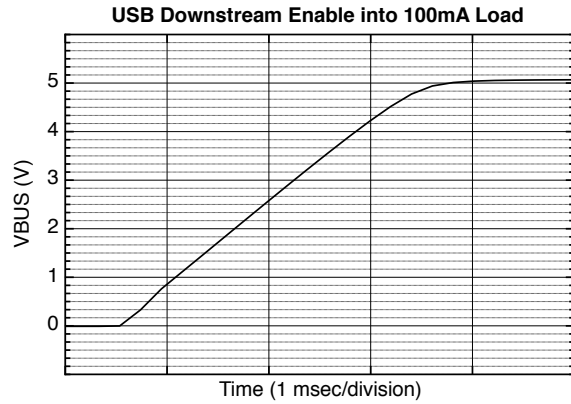

Figure 2: V_{bus} rise time after with 100mA constant load.

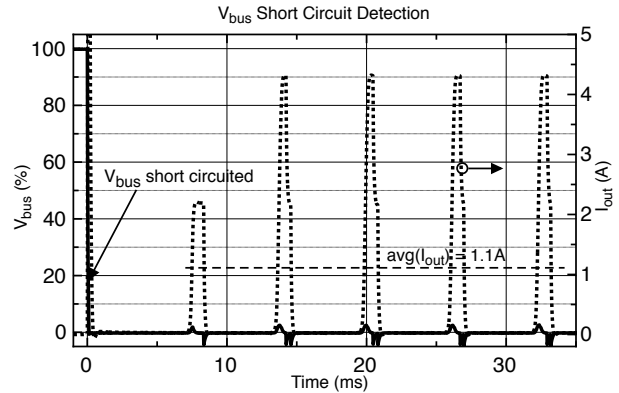

Figure 4: V_{bus} short-circuit mode behavior.

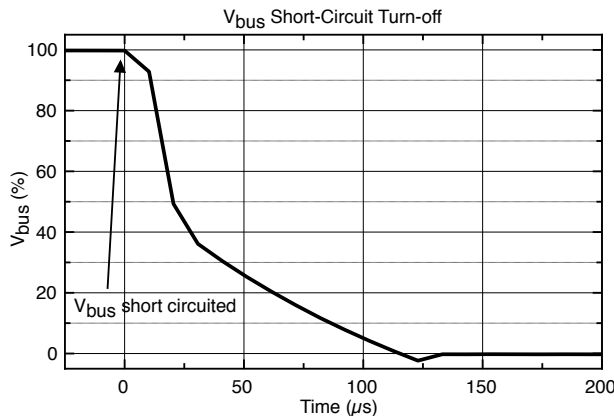

Figure 3: V_{bus} turn-off time after short-circuit.

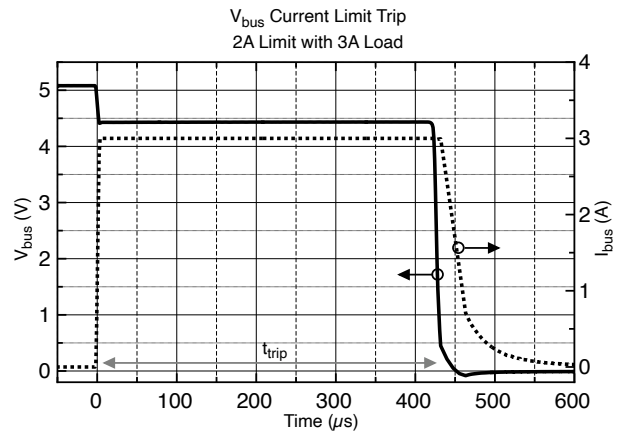

Figure 5: V_{bus} programmable current limit response, t_{trip} .

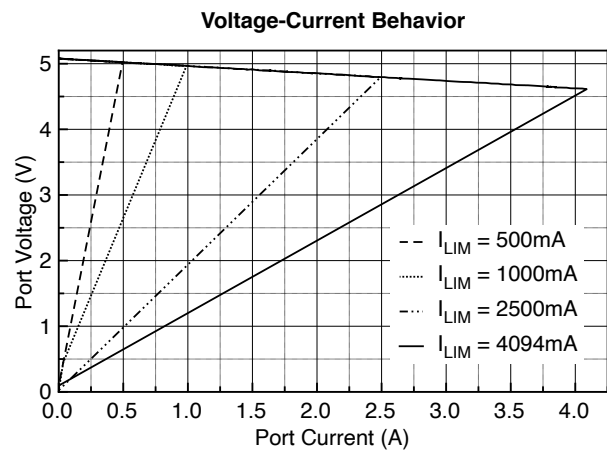

Figure 6: V_{bus} Current Limiting Behavior (V-I)

Overview

With advanced programmable control features, the USBHub3+ is targeted at industrial and production systems requiring software and embedded control of USB devices. It is ideal for manufacturing test of consumer electronics and control of industrial systems.

Power Subsystem

The USBHub3+ has an internal over-voltage, under-voltage, and over-temperature protected switch mode power supply that generates V_{bus} for all downstream ports and the USBHub3+'s system power. This supply is also protected by an output current limit that determines the total V_{bus} Output Power specified in the Absolute Maximum Ratings section. Also see the Input Power Connections section for details on powering the USBHub3+.

Grounding

USB is sensitive to grounding and ground loops. Is important to understand your system's grounding strategy to ensure the USB shield or ground is not the primary ground current return path. The USBHub3+ shorts USB shield and ground and provides an earth ground connection point. Instructions for separating shield and earth ground from USB and system ground can be obtained by contacting Acroname support.

Ground isolation methods such as optical isolators and isolated power supplies have been demonstrated to work well with the USBHub3+.

Charging Standards

All Downstream ports support USB Battery Charge version 1.2 (BC 1.2) in the following modes: standard downstream port (SDP), charging downstream port (CDP), and dedicated charging port (DCP) modes. While the hub has an upstream connection enumerated, SDP and CDP modes are available. If an upstream enumeration is not present, DCP mode is available.

The defaults to a USB compliant mode, which means it will manage toggling V_{bus} on change of upstream enumeration. This toggling facilitates changing downstream devices changing from USB DCP to CDP mode. In some applications, this behavior may not be desired; that is, it may be desired that V_{bus} state should only change based when commanded via the API. The auto-toggling of V_{bus} behavior can be controlled with the Auto V_{bus} Toggle bit in the USB Port Mode section of the API.

With Auto V_{bus} Toggle enabled, downstream ports in SDP and CDP mode will cycle their V_{bus} power if there is a change to upstream enumeration.

If there is no upstream connection and a downstream-facing port is in SDP mode, V_{bus} for the downstream port will be

automatically disabled. V_{bus} will return with the return of an upstream enumeration.

All ports configured as CDP/DCP will act as CDP while there is an upstream connection and as DCP while there is no upstream enumeration.

Bus Measurement Subsystem

The measurement subsystem of the USBHub3+ samples V_{bus} voltage and current for all 8 programmable downstream ports and the input voltage. Voltage and current measurements for a single port are done sequentially and interleaved with 2 other port measurements. Each sample of voltage or current takes $140\mu s$. For most USB applications these measurements are considered "instantaneous" and "simultaneous" so they make a reasonable measurement of port power consumption. Measured samples of voltage or current are then averaged in a first-order IIR exponential moving average filter with a decay factor of 4. The sampling time diagram and averaging filter are illustrated in Figure 7 and Figure 8.

Average filter operation begins by converting a sample of voltage or current for one port. This value is then subtracted from the previous value that was present in the corresponding measurement output. This difference is then divided by 4 and stored in an internal accumulation register. The computed measurement result is then added to the previous measurement output value, and the resulting value is updated as the new measurement output. After the update, the next signal to be measured follows the same process.

The filter response to a step in the input takes 8 samples (6.7ms) to be within 10% of the input value; 16 samples (13.4ms) to be within 1% of the input value.

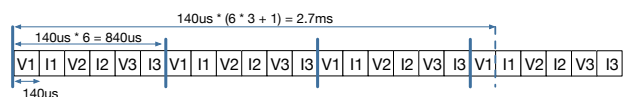

Figure 7: Measurement sample timing diagram

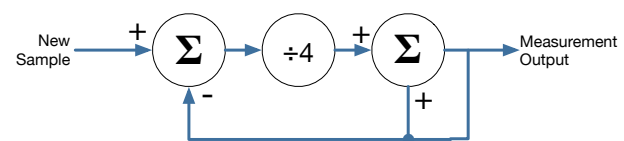

Figure 8: Averaging filter flow

Current Limiting Behavior

There are two current limits in the USBHub3+: the programmable limit and short-circuit limit. The programmable current limit sets a circuit-breaker style trip point which disables the port if the current goes above the set limit. V_{bus} current for this trip point is based on the averaged current value. If any averaged current sample on a port is higher than the

programmed limit for that port, the port trips off. When a port trips, the USBHub3+ sets the overcurrent flag (see [USB Port Error Status Mapping](#)) and disables the port after t_{trip} . A device is allowed to draw up to the short-circuit current limit until the port is disabled. This behavior is detailed in Figure 5.

Since the system can only read V_{bus} current up to 4095mA, setting a limit of 4095mA (which is the default limit) effectively disables the programmable current limit.

A short-circuit on V_{bus} is current limited to I_{limit} . Any current over I_{limit} will cause V_{bus} to enter short-circuit mode after t_{limit} . Higher current may flow within t_{limit} . After entering short-circuit mode, assuming the programmable current limit is not tripped, the port will supply an average of I_{short} . If the system is using Auto Vbus Toggle, a short-circuited port will remain in short-circuit mode until the short-circuit is removed or the load current drops below I_{limit} ; no error flags are set.

If the system is not using Auto V_{bus} Toggle, the port's V_{bus} will be disabled approximately 200ms after detecting the short-circuit and a short-circuit error flag will be set (see [USB Port Error Status Mapping](#)) and the port will indicate the V_{bus} state as off (see [USB Port State Mapping](#)). The port's V_{bus} will be automatically enabled at approximately 500ms intervals until the short is removed. Short-circuit mode will continue until the short-circuit is removed or the load current drops below I_{limit} . The short-circuit behavior is detailed in Figure 3 and Figure 4.

Short-circuit mode may also be entered when enabling a port connected to a low-resistance or high-capacitance load. If instantaneous V_{bus} current rises above 2.5A when a port is enabled may cause the port to enter short-circuit mode.

Overvoltage and Reverse Current

V_{bus} voltage and current are continuously monitored for overvoltage and reverse current. If the voltage is consistently over V_{ov_thresh} or the current is negative for approximately 200ms, the port's overvoltage error flag will be set (see [USB Port Error Status Mapping](#)) and the port will indicate the V_{bus} state as off (see [USB Port State Mapping](#)). After the fault condition is removed, the port V_{bus} will be re-enabled after t_{ov_en} .

Software Control

The USBHub3+ is built on Acroname's BrainStem system, which provides simple high-level APIs, a real-time embedded runtime engine and modular expandability.

Software control of the features of the USBHub3+ is done with the BrainStem API via a BrainStem link. BrainStem links are done over USB and can be established via upstream port 0 (Up0), upstream port 1 (Up1), or the Control Port. After one or more of these ports is connected to a host machine, a user can connect to it via software on the host. An example graphical user

interface application is available at <https://acroname.com/software>.

Functionality details unique to the USBHub3+ are in the online API documentation. For more information on getting started with software control of the USBHub3+, see the online reference documentation at <https://acroname.com/reference/>.

BrainStem Control Port

The USBHub3+ also has a dedicated control channel on the USB mini-B connector. This is a full-speed USB2 connection for BrainStem interface only. No USB hub traffic can flow on this connection. When a cable is connected to the mini-B connector, the BrainStem link can only be established through the Control Port, independent of the selected upstream port. The USB3 type-B connectors are then used only for USB hub traffic to connect downstream USB devices. When the Control Port is not used, the BrainStem link will share the active upstream USB connection. Using the Control Port provides the ability to completely disconnect both USB upstream host connections while maintaining software control of the hub. Figure 9 details the decision tree for selecting the port used to establish a BrainStem link.

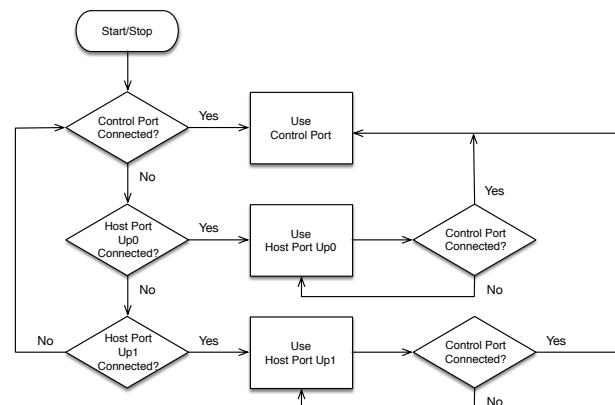

Figure 9: Determining connection used for BrainStem communications

Using Multiple Hosts with USBHub3+

The two upstream-facing host ports can be connected to two different host computers. The control port can be attached to no computer, one of the same computers attached to the upstream ports, or a third host computer. Due to limitations of USB specification, only one host computer can access downstream USB ports at any time. Through the BrainStem API, the upstream port used can be controlled, or the system can automatically select the upstream port (see USB Hub Upstream Mode). When automatically selecting the upstream port, the USBHub3+ will favor using Up0 if it is connected.

Device Drivers

The USBHub3+ leverages operating system user space interfaces that do not require custom drivers for operation on modern operating systems.

Some older operating systems may require the installation of a BrainStem USB driver to enable software control. Installation details on installing USB drivers can be found within the BrainStem Development Kit under the “drivers” folder. For example, Windows 7 requires the supplied INF to communicate with BrainStem USB devices.

Connections and LED Indicators

The front and back of the USBHub3+ have a set of connectors and LEDs to indicate control information and connectivity status. The meaning and location of each connector and LED are described in the following tables and diagrams.

LED Name	Color	Description
Link Status LED	Yellow	On once a host device has enumerated the BrainStem controller
User LED	Blue	Can be manipulated through any of the available APIs
Heartbeat LED	Green	Indicates active BrainStem connection; pulses at a rate determined by the system heartbeat rate
Power/Watchdog LED	Red and flashing blue	Solid red indicates the system is powered. Flashing blue is indication the internal watchdog is running and the USBHub3+ firmware is healthy
Upstream Operational Speed LED	Yellow or green	Upstream enumeration speed to host: green for SuperSpeed; yellow for Hi-Speed or lower USB2 speeds.
Upstream 0 LED	Green	Indicates an active connection on upstream port
Upstream 1 LED	Green	
Control Port LED	Yellow	
Downstream Operational Speed LED	Yellow or green	Downstream device enumeration speed: green for SuperSpeed; yellow for Hi-Speed or lower USB2 speeds; off when no device is enumerated
Downstream Power LED	Red	LED is on when downstream V_{bus} is enabled

Table 5: LED indicators

Connection Name	Type	Description
Front Panel, 0-7	USB3 Type A	Downstream-facing connections to USB devices Each port is controlled and monitored by BrainStem API
Down A	USB3 Type A	Downstream-facing connection to USB devices This port is always on and is not controlled or monitored by BrainStem API
Control Port	USB2 mini-B	Dedicated BrainStem control command access
Up0	USB3 Type B	Upstream-facing connections for a USB host to access downstream devices Selected UpX provides BrainStem control command access if Control Port is not connected
Up1	USB3 Type B	
Barrel Power Input	Black Barrel-type	External power input
Euro-Style Power Input	Green Phoenix-type	External power input

Table 6: USBHub3+ External Connections

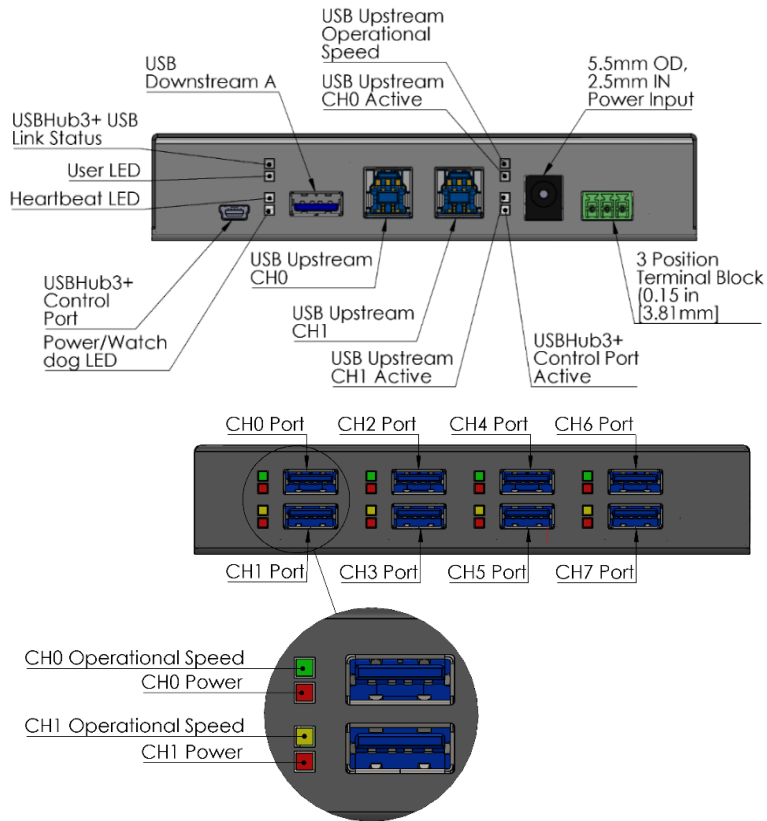

Figure 10: Connections and LED Indicators

Mechanical

Dimensions are shown in inches [mm]. 3D CAD models available from <https://acroname.com>.

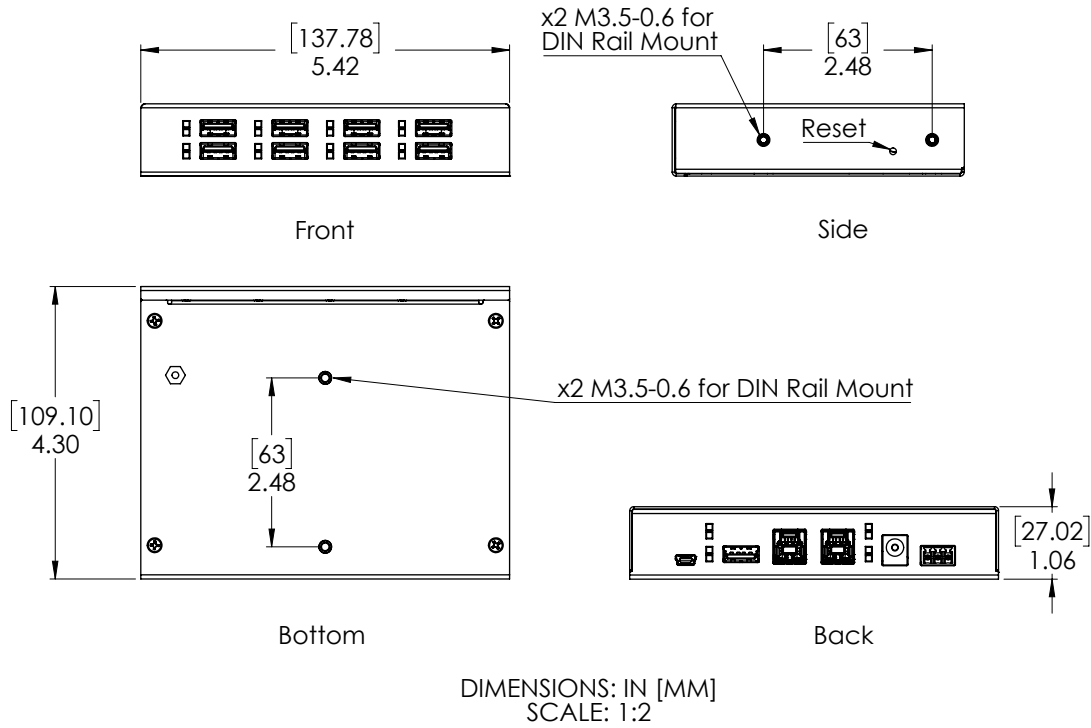

Figure 11: USBHub3+ Mechanical

Housing Markings

Symbol	Description
-	V_{supply} Negative Return
+	V_{supply} Positive Input
	Shield / chassis terminal. GND and SHIELD are connected internally.
	DC barrel connector polarity marking
	DC line voltage
	Hot parts! Burned fingers when handling the parts. Wait one-half hour after switching off before handling parts.

Table 7: Case Symbol Markings

DIN Rail Mounting

DIN rail mounting provisions have been designed into the USBHub3+ case. Holes for a DIN rail clip/adaptor are provided to allow mounting of the USB3+ hub to standard DIN rails. Mounting clip hardware is available separately in a kit from Acroname: part number C31-DINM-1. The diagrams below illustrate USBHub3+ mounted in two orientations:

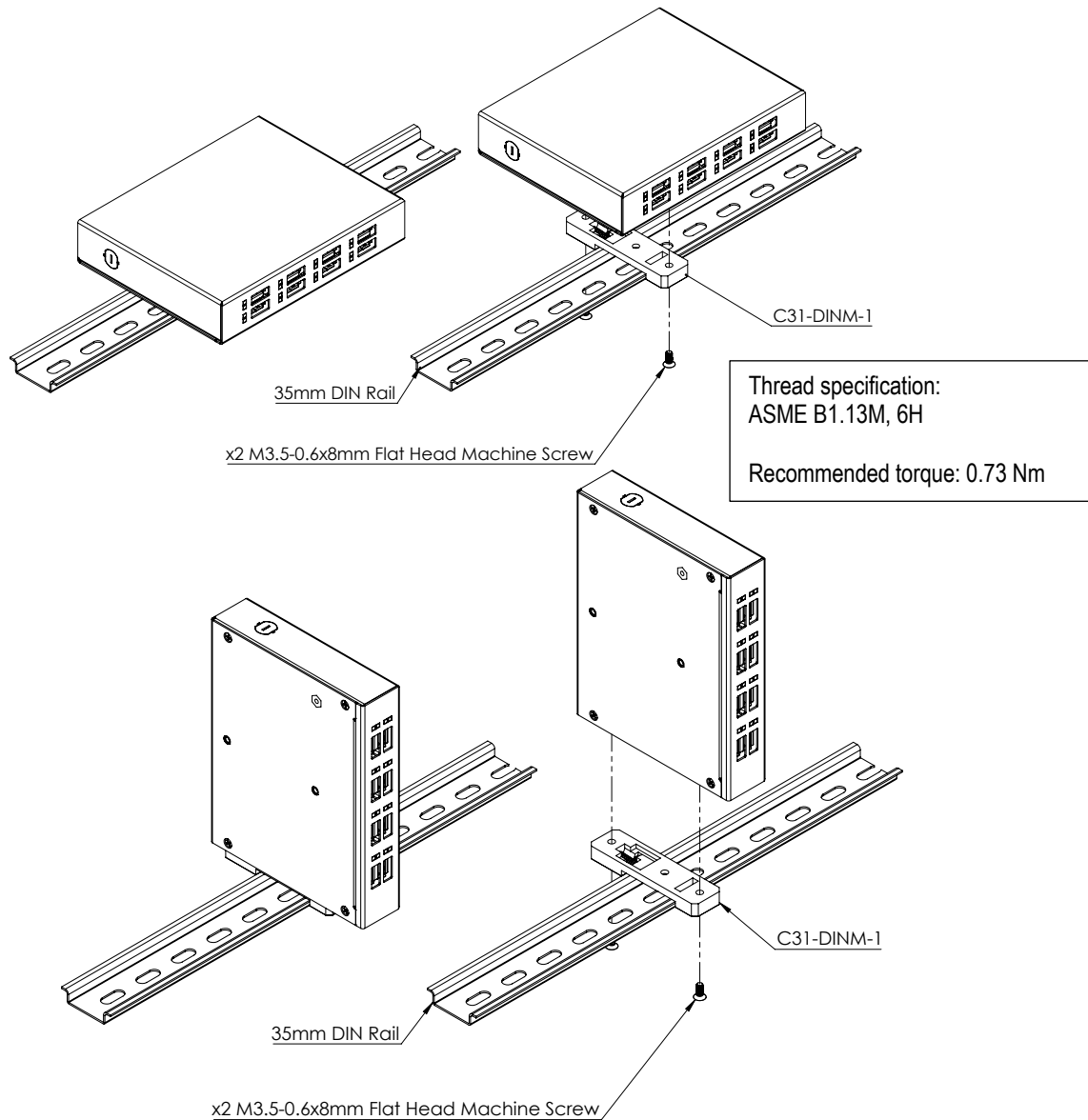

Figure 12: USBHub3+ DIN Rail Mount

Important Note

See instructions included in the C31-DINM-1 Kit. Acroname recommends using only the hardware provided in the C31-DINM-1 kit. Installing the DIN rail mount bracket without the included washers or with screws that are too long may damage the product and void any warranty.

Input Power Connections

The USBHub3+ can be powered in two ways: the DC “barrel-jack”; a “Euro-style” terminal block.

Certifications and specifications are only valid with the Acroname provided power supply. Other power supplies can result in unspecified behaviors. Contact Acroname support for guidance on alternative power supplies. Replacement power supplies and AC main cords are available from Acroname. Acroname recommends against replacing the detachable AC Mains supply cord provided with the inadequately rated cables. Replacement power supplies are available Acroname part number: R469-PS-3 (<https://acroname.com/store/r469-acdc-ps-3>) for powering through the DC barrel-jack. DC power supplies connecting through the Euro-style 3-pin terminal block must adhere to safe power and thermal operational standards⁵. Power supply equipment shall be powered using separately approved (IEC/UL/EN 62368 or IEC/UL/EN 60950) power supply with output power be limited to 70W as specified in Table 3: Recommended Operating Ratings.

The DC barrel-jack is a standard 5.5mm outside diameter, 2.5mm inside diameter, 9.5mm mating length connector with limited current rating as specified in Table 1: Absolute Maximum Ratings. The mating plug is a 5.5mm outside diameter, 2.5mm inside diameter plug. Many manufacturers make compatible mating plug connectors; one example is the DC barrel plug from CUI: part number PP3-002B (<https://www.cuidevices.com/product/resource/pp3-002b.pdf>).

In addition to the standard barrel jack power input an alternative power input, a Euro-style 3-pin terminal block (“Euroblock”), is also provided. This connector provides the additional benefits of a dedicated earth connection and a higher current rating (10A) than the barrel connector (5A). From left to right, the pins are V_{supply} (pin 1), GND, and SHIELD. GND and SHIELD are connected internally.

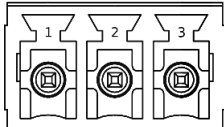

Figure 13: Euro-style 3-pin terminal block

Many manufacturers make compatible mating connectors; one example is the Würth Elektronik Series 3663- 3.81mm Horizontal with Hook on Back Side WR-TBL, part number 691366310003 (<https://www.we-online.de/katalog/datasheet/6913663100xx.pdf>).

FCC Compliance Statement

This equipment has been tested and found to comply with the limits for a Class B digital device, pursuant to part 15 of the FCC Rules. These limits are designed to provide reasonable protection against harmful interference in a residential installation. This equipment generates, uses and can radiate radio frequency energy and, if not installed and used in accordance with the instructions, may cause harmful interference to radio communications. However, there is no guarantee that interference will not occur in a particular installation. If this equipment does cause harmful interference to radio or television reception, which can be determined by turning the equipment off and on, the user is encouraged to try to correct the interference by one or more of the following measures:

- Reorient or relocate the receiving antenna.
- Increase the separation between the equipment and receiver.
- Connect the equipment into an outlet on a circuit different from that to which the receiver is connected.
- Consult the dealer or an experienced radio/TV technician for help.

This device complies with part 15 of FCC Rules. Operation is subject to the following two conditions; (1) This device may not cause harmful interference, and (2) this device must accept any interference received, including interference that may cause undesired operation.

Compliance Information

ACRONAME

S79-USBHUB-3P
 Programmable USB 3.2 Gen1 Hub
 Input: Input: 9-24 V= 70W
 Output: 5V= 4A
 Country of Origin: United States of America

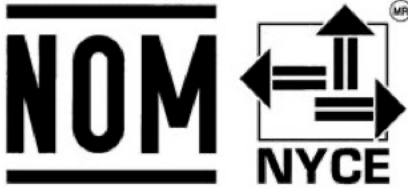

ACRONAME

S79-USBHUB-3P
 Programmable USB 3.2 Gen1 Hub
 Input/輸入 :9-24 V= 70W
 Output/輸出:5V= 4A
 Country of Origin: United States of America



D43681
RoHS

警告:為避免電磁干擾, 本產品不應安裝或使用於住宅環境。

BSMI Precautions For Safe Handling

此設備不適用於兒童可能出現的區域

- 不使用時, 請先斷開外部設備與產品的連接(例如, 關閉外部設備或從電腦“安全彈出”外部設備), 然後斷開產品與電腦的連接。
- 請勿強行插拔產品, 以免損壞。
- 請保持產品在乾燥環境中運行和存放。

BSMI RoHS Table

設備名稱： Programmable USB 3.2 Gen1 Hub Equipment name 型號（型式）： S79-USBHUB-3P Type designation (Type)						
單元Unit	限用物質及其化學符號 Restricted substances and its chemical symbols					
	鉛Lead (Pb)	汞Mercury (Hg)	鎘Cadmium (Cd)	六價鉻 Hexavalent chromium (Cr ⁶⁺)	多溴聯苯 Polybrominate d biphenyls (PBB)	多溴二苯醚 Polybrominate d diphenyl ethers (PBDE)
機殼 Chassis	○	○	○	○	○	○
電路板 PCB Board	○	○	○	○	○	○
連接器 Connector	○	○	○	○	○	○
電子元件 Electronic Component	○	○	○	○	○	○
備考1. “超出0.1 wt %” 及 “超出0.01 wt %” 係指限用物質之百分比含量超出百分比含量基準值。 Note 1 : “Exceeding 0.1 wt %” and “exceeding 0.01 wt %” indicate that the percentage content of the restricted substance exceeds the reference percentage value of presence condition. 備考2. “○” 係指該項限用物質之百分比含量未超出百分比含量基準值。 Note 2 : “○” indicates that the percentage content of the restricted substance does not exceed the percentage of reference value of presence. 備考3. “-” 係指該項限用物質為排除項目。 Note 3 : The “-” indicates that the restricted substance corresponds to the exemption.						

Product Support

Questions about the product operation or specifications are welcome through Acroname's contact portals. Software downloads, reference API and application examples are available online at:

<https://acroname.com/support>

Direct communication and additional technical support are available at:

<https://acroname.com/contact-us>

2741 Mapleton Avenue

Boulder, CO, USA 80304-3837

720-564-0373 (phone)

Document Revision History

All major documentation changes will be marked with a dated revision code

Revision	Date	Engineer	Description
1.0	September 2016	JTD	Initial Release
1.1	September 2016	JLG	Update block diagram
1.2	October 2016	LCD	Update Overview, Features, Description Text
1.3	October 2016	LCD	Update ESD compliance info
1.4	January 2017	JLG	Add V_{bus} overvoltage information; add voltage and current measurement accuracy
1.5	February 2017	JLG	Add port state to saved parameters
1.6	March, 2017	JTD	Updated DIN mount screw spec
1.7	October, 2017	JLG	Update overvoltage and reverse current spec
1.8	April 2018	RMN	Removed Hub State for Port State
1.9	September 2018	LCD	Updated control path diagram
1.9.1	October 2018	LCD	Updates to support online BrainStem API documentation
1.9.2	October 2018	LCD	Added documentation on <code>usb.getUpstreamState()</code> ; other minor corrections
1.9.3	November 2018	LCD	Improved Input Power Connections section; minor corrections
1.10	March 2019	JLG	Added spec for DIN mount hole PEM nut and torque Correct max current specification Add details on current limit behavior
1.11	February 2020	JLG	Added measurement subsystem section Corrected t_{trip} specification
1.12	July 2020	ACRO	Formatting update; clarify connection information; add humidity spec
1.13	June 2020	TDH	Added Euro-style terminal block pinout
1.14	Jan 2021	JLG	Add V-I current limiting behavior
1.15	February 2021	MJK	Contact information for technical support
1.16	February 2021	RMN	Fixed typo in upstreamMode enumeration.
1.17	February 2021	GCF	Fixed connector links
1.18	June 2021	MJK	Added case symbol markings
1.19	July 2021	MJK	Information on AC power cords and replacement options.
1.20	August 2021	JLG	Remove software API documentation. Moved to online reference.
1.21	September 2021	JLG	Clarify USB 3.2 Gen 1 compliance
1.22	October 2021	JLG	Add V_{bus} overvoltage and reverse current behavior
1.23	January 2022	TDH	Clarify absolute and recommended voltage limits for V_{BUS}
1.24	March 2022	MJK	Input power supply details and information
1.25	March 2022	MJK	Power input details updates in specifications tables.
1.26	March 2022	MJK	Included hot warning symbol in marking table.
2.26	March 2022	MJK	Ambient temperature operation range is limited to 25°C to support IEC 69050 safety standards.
2.27	August 2022	GCF	Included NOM label and BSMI compliance label/RoHS table Added additional BC 1.2 information
2.28	August 2022	FEC	Included BSMI compliance label and RoHS table
2.29	September 2022	GCF	Added additional BC 1.2 information
2.30	October 2022	JLG	Update system block diagram; clarify USB 5Gbps compliance
2.31	February 2023	MJK	Image consistency with other documentation
2.32	April 2023	JLG	Clarify short-circuit detection behavior
2.33	October 2023	MJK	Update to BSMI compliance
2.34	October 2023	TDH	Clarify Power Subsystem details
2.35	November 2023	GCF	Update BSMI Precautions

2.36	December 2023	MJK	Clarification on ambient operating temperature
2.37	January 2024	CWG	Correct max voltage specification